

4.80 H RM

Automotive lift date: 11/99

Manual date: 28.12.99

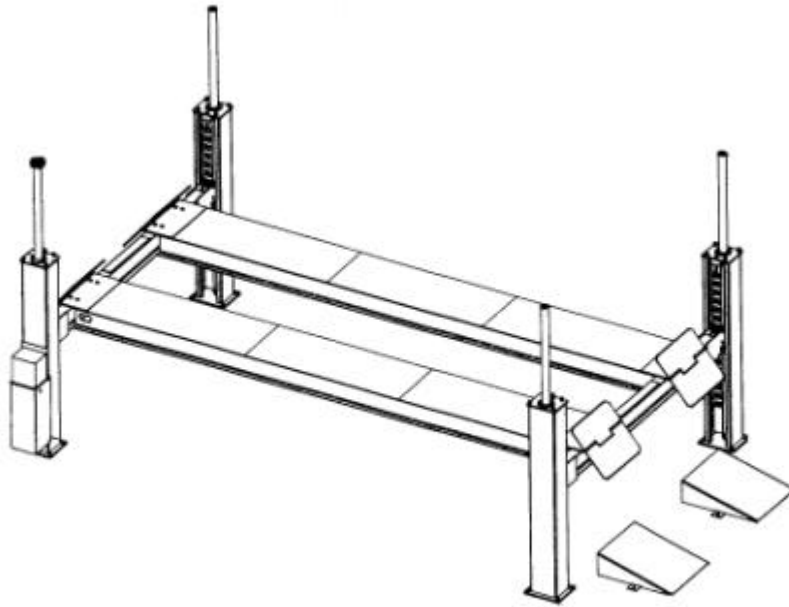

Operating instruction and documentation

Serial number:

retailer/ phone



NUSSBAUM
HEBETECHNIK

Nußbaum Hebetechnik GmbH & Co.KG//Korker Straße 24//D-77694 Kehl-Bodersweier//Tel: +49(0)7853/8990
Fax: +49 (0) 78 53 / 87 87//E-mail: info@nussbaum-lifts.de//http://www.nussbaum-lifts.de

Contents

Foreword.....	3
Record of installation.....	5
Record of handing over.....	6
1. Introduction.....	7
1.1 Installation and check of the automotive lift.....	7
1.2 Information of Warning.....	7
2. Master of the document.....	8
2.1 Lift- manufacturer.....	8
2.2 Application.....	8
2.3 Changes at the construction.....	8
2.4 Displacement of the automotive-lift.....	8
2.5 CE-Certificate/attestation of conformity.....	9
3. Technische Information.....	10
3.1 Technical ratings.....	10
3.2 Safety devices.....	10
3.3 Datasheet.....	11
3.4 Foundation plan.....	12
3.5 Hydraulic diagram.....	13
Hydraulic part list	14
3.6 Electrical diagram drawing.....	15
Electrical part list.....	19
4. Safety regulations.....	20
5. Operating instructions.....	20
5.1 Lifting the vehicle.....	20
5.2 Lowering the vehicle.....	21
5.3 Lowering the lift in the ratchet.....	21
5.4 Function Microprocessor / Display-ad.....	21
5.5 Driving on an obstacle.....	22
6. Troubleshooting.....	22
6.1 Emergency lowering.....	23
7. Maintenance.....	24
7.1 Inspection and Maintenance of Nussbaum lifts.....	24
7.2 Cleaning the automotive-lift.....	25
8. Security check.....	26
9. Installation and Initiation.....	27
9.1 Installation of the automotive lift.....	27
9.2 Regulations for the installation.....	27
9.3 Adjusting the rail.....	28
9.4 Changing the installation place.....	28
9.5 Initiation.....	29
<u>Appendix</u>	
Selection of Dowels.....	30
Document "First security check before Installation".....	31
Document "Regular security check".....	32
Document "Extraordinary security check".....	41
Manual service operation over the keyboard.....	42

Foreword

Nußbaum-Lifts are a result of long-standing experiences.

The high quality and the superior concept guarantee them reliability, a long lift time and the economic business.

To avoid unnecessary damages and dangers, read the operating instruction attentive and observe the contents.

Another or the described purpose going out use is not valid when not as agreed.

This is valid particularly for climb and go.

Company Nußbaum is not liable for damages arising from this. The user carries the risk a lonely.

For the use belonged:

- to observe all the notice in the operating instruction and
- the following of the inspection and maintenance work and the prescribed tests.
- The instruction for use have to be observed by all persons working with the lift.
- Especially the chapter "Safety/accident Prevention" has to be observed.
- In addition to the safety remarks of the instructions for use the regulations and instructions being valid at the place of operation have to be considered.

Obligations of the operator:

The operator is obliged to allow only those persons complying to the following requirement to work at the unit

- being well acquainted with the basic regulations concerning labour safety and accident prevention and being trained to operate the unit.
- having read and understood the chapter concerning safety and warning instructions and confirmed that by their signature.

Dangers when operating with the lift:

The Nußbaum-Lifts are designed and built according to technical standard and the approved regulations for technical security. Yet, danger for body and life of the operator may turn up when using the lift inexpertly.

The lift must only be operated :

- for its appropriate use
- in unobjectionable condition concerning technical security.

Organising requirements

- The instructions for use are constantly to be kept at the place of operation being at hand at any time.
- In addition to the instructions for use rules pertaining to other regulations i.e. accident prevention and environmental rules are to be observed and directed.
- Safety- and danger alert operation of personal is occasionally and by observing the instructions for use to be controlled.
- As far as required and ordered by regulations personal protective equipment is to be used
- All safety- and danger-hints at the lift are to be observed!
- Spare parts must comply with technical requirements laid down by the manufacturer. This is only warranted with original parts.
Consider time intervals given or fixed in instructions for use for repeated tests/inspections.

Maintenanceworks, remedy of faults and disposal

- Fixed Adjusting-, maintenance- and inspectionworks and time intervals including Details for exchange of parts/part components as mentioned in the instructions for use are to be adhered.
These works must only be carried out by expert personal.
- After maintenance- and repair works loose screw connections must always be firmly tightened!



Filling out and undersigned and copying this sheet and send the original to the lift manufacturer. The copy remains in the Manual.

Otto Nußbaum Hebetchnik GmbH & Co. KG
Korker Straße 24
D-77694 Kehl-Bodersweier

Record of installation

The automotive lift 4.80 H RM with the
serial number:..... was installed on:.....
at the firm:..... at:.....
the safety was checked and the lift was started.

The installation was effected from the operating authority/competent (please delete as applicable).

The safety of the automotive lift was checked from the competent before the initial operation.

The operating authority attest the installation of the automotive lift, the competent attest the correct initial operation.

.....
date	name of the operating authority	signature of the operating authority

.....
date	name of the competent person	signature of the competent person

Your customer service is the company:.....

.....

Record of handing over

The automotive lift 4.80 H RM with the

serial number:..... was installed on:.....

at the firm:..... at:.....

the safety was checked and the lift was started.

The persons below were introduced after the installation of the automotive lift. The introduction was carried out from an erector of the lift-manufacturer or from a franchised dealer (competent person).

.....
date name signature

.....
date name signature

.....
date name signature

.....
date name signature

.....
date name signature

.....
date name signature

.....
date name of competent signature of the competent

Your customer service is the company:.....

.....

1. Introduction

The document "Operating Instructions and Documentation" contains important information about installation, operation and maintenance of the Lift.

To furnish proof of **installation of the automotive lift** the form "Record of Installation" must be signed and returned to the manufacturer.

To furnish proof of the singular, felt this documentation contains forms. The forms should be used to document the checks. They should not be removed from this documentation.

Every **Changes to the construction and displacement** of the automotive lift must be registered in the "Master document" of the lift.

1.1 Installation and check of the automotive lift

Only specialist staff is allowed to do work concerning safety and to do the safety checks of the lift. They are called experts and competent person in this document.

Experts are persons (for example self-employed engineers, experts) which have received instruction and have experience to check and to test automotive lifts. They know the relevant labour and accidents prevention regulations.

Competent person are persons who have acquired adequate knowledge and experience with automotive lifts. They took part in training from the lift-manufacturer (servicing technicians of the manufacturer or dealer, are competent)

1.2 Information of Warning

To show danger and to show important information the three symbols below are used. Pay attention to those passages, which are marked with these symbols



Danger! This sign indicates danger to life. Inexpert handling of the described operation may be dangerous to life.



Caution! This sign cautions against possible damage to the automotive lift or other material defects in case of inexpert handling .



Attention! This sign indicates for an important function or other important notes.

2. Master document of the automotive lift

2.1 Lift –manufacturer Otto Nußbaum Hebeteknik GmbH & Co. KG
Korker Straße 24
D-77694 Kehl-Bodersweier
Germany

2.2 Application

The automotive lift 4.80 H is a lifting mechanism for lifting motor vehicles with a laden weight of up to 8000 kg. The max. load distribution is 2:1 in or against drive-on direction. The automotive lift is only designed for servicing vehicles. It is not allowed to carry persons with the lift.

It's not allowed to install the standard-automotive lift in a hazardous location or washing bays.

2.3 Changes at the construction

Changes at the construction, expert checking, resumption of work (date, kind of change, signature of the expert)

.....
.....
.....
.....

name, address of the expert

.....
place, date

.....
signature of the expert

2.4 Displacement of the automotive-lift

Displacement of the automotive-lift, expert checking, resumption of work (date, kind of change, signature of the competent)

.....
.....

name, address of the competent

.....
place, date

.....
signature of the competent

2.5 CE-Certificate/attestation of conformity

The automotive lift 4.80 H RM with the serial number.....
Is in accordance with the tested lift (CE-certificate-number 04-205-1638/00)

.....
place, date

.....
company stamp, signature

ZERTIFIKAT					
CERTIFICATE					
RWTÜV					
Registrier-Nr./Registered No.: 04 205-1638/00					
EG-Baumusterprüfbescheinigung gemäß Anhang VI der EG-Richtlinie 98/37/EG EC-type approval according to annex VI of the EC-Directive 98/37/EC					
Zeichen des Auftraggebers Reference of applicant	Auftragsdatum Date of application	Aktenzeichen File reference	Prüfbericht Nr. Test report No.	Ausstellungsdatum Date of issue	Gültigkeit bis Expiry date
Hr. Müller	29.06.1999	3.1.1-821/99	1636/00	14.07.2000	14.07.2005
Hiermit wird bestätigt, daß das nachfolgend genannte Produkt den grundlegenden Anforderungen der Richtlinie des Rates vom 22.06.98 zur Angleichung der Rechts- und Verwaltungsvorschriften der Mitgliedstaaten über Maschinen entspricht. We hereby certify that the product mentioned below meets the basic requirements of the council directive dated 22.06.98 on the approximation of the laws, regulations and administrative provisions of the member states relating to machinery.					
CE 0044					
Antragsteller Applicant:	Otto Nußbaum GmbH & Co. KG Korker Straße 24, D-77694 Kehl				
Fertigungsstätte: Manufacturing plant:	s.o.				
Produktbeschreibung: Product description:	Kfz.-Hebebühne (car lifter): Nutzlast (nominal load): max. Nutzhub (max. elevation):		4.80 H RM 8000 kg 1750 mm		
 Zertifizierungsstelle des RWTÜV e.V. für Gerätesicherheit, Aufzüge und Medizintechnik, notifiziert bei der EG-Kommission unter Nr. 0044			Rheinisch-Westfälischer Technischer Überwachungs- Verein e.V., Sitz: Essen Langemarkstraße 20 D-45141 Essen Postfach 10 32 61 D-45032 Essen Telephone +49/201 8 25-0 Telefax +49/201 8 25-33 56		

3. Technical Information

3.1 Technical ratings

Capacity	8000 kg
Load distribution	2:1 in or against drive-on direction
Lifting time	approx. 68 sec.
Lowering time	approx. 72 sec.
Line voltage	3 x 400 Volt , 50Hz
Power rating	3 kW
Motor speed	2800 rotation/Minute
Pump capacity	3 ccm
Hydraulic pressure	approx. 250 bar
Pressure relief valve	approx. 270 bar
Oiltank	approx. 55 Litre
Sound level	≤ 75 dBA
Connection by customer (standard)	3~/N+PE, 400V, 50 Hz with fuse T16A (Pay attention to the tension of your state)

3.2 Safety device

1. Pressure relief valve
Overprint-safety of the hydraulic system
2. Holding valve
Safety device against unintentional lowering
3. Lockable main switch
Safety device against unauthorised operation
4. Return rolls protection
Safety device against rolling back
5. CE-Stop
protection against squashes
6. Microprocessor controlled synchronism
Protection against unsynchronism of the lift
7. Safety ratchets
safety device against unintentional lowering
8. Microprocessor controlled limit switch

3.3 Datasheet

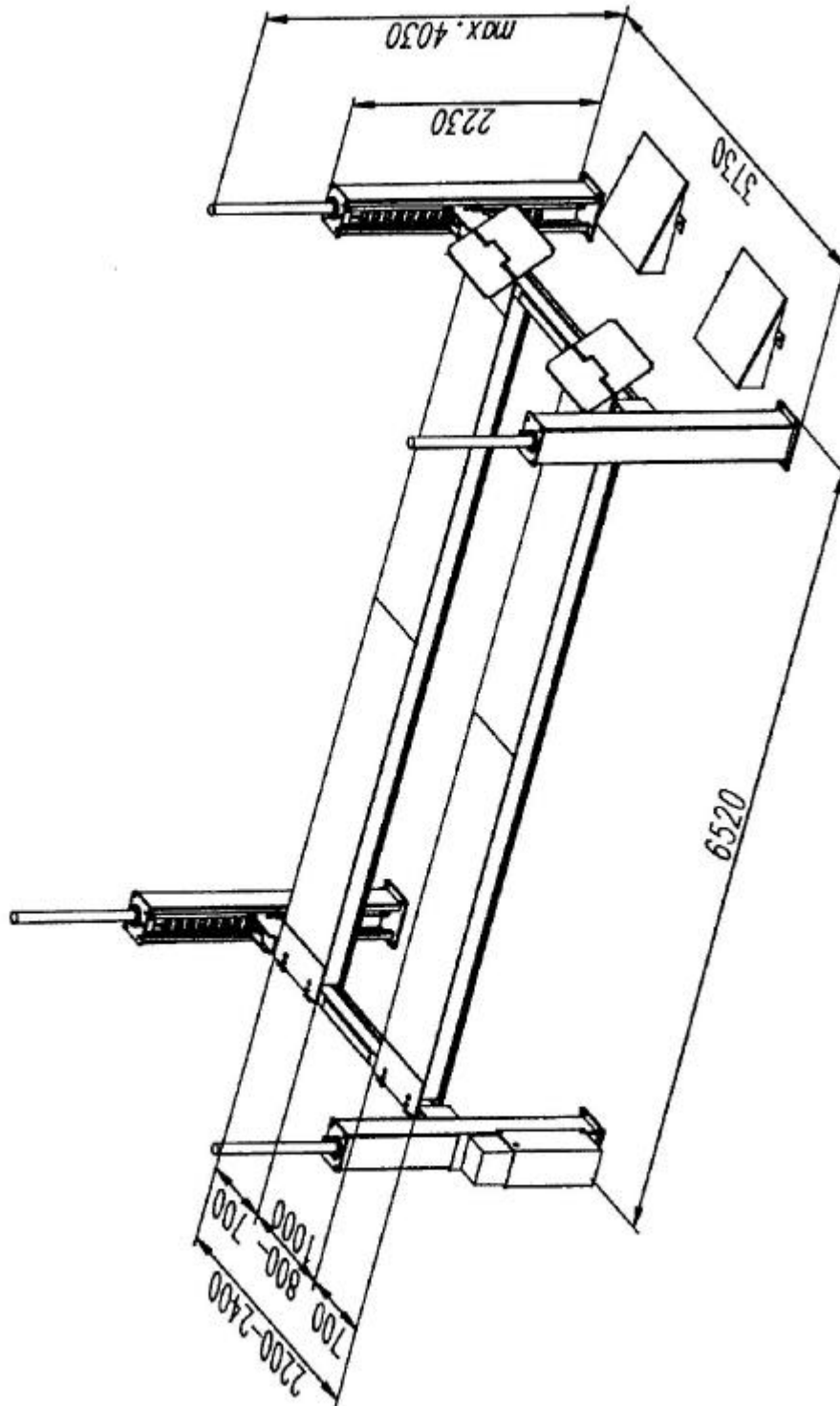

3.4 Foundation plan

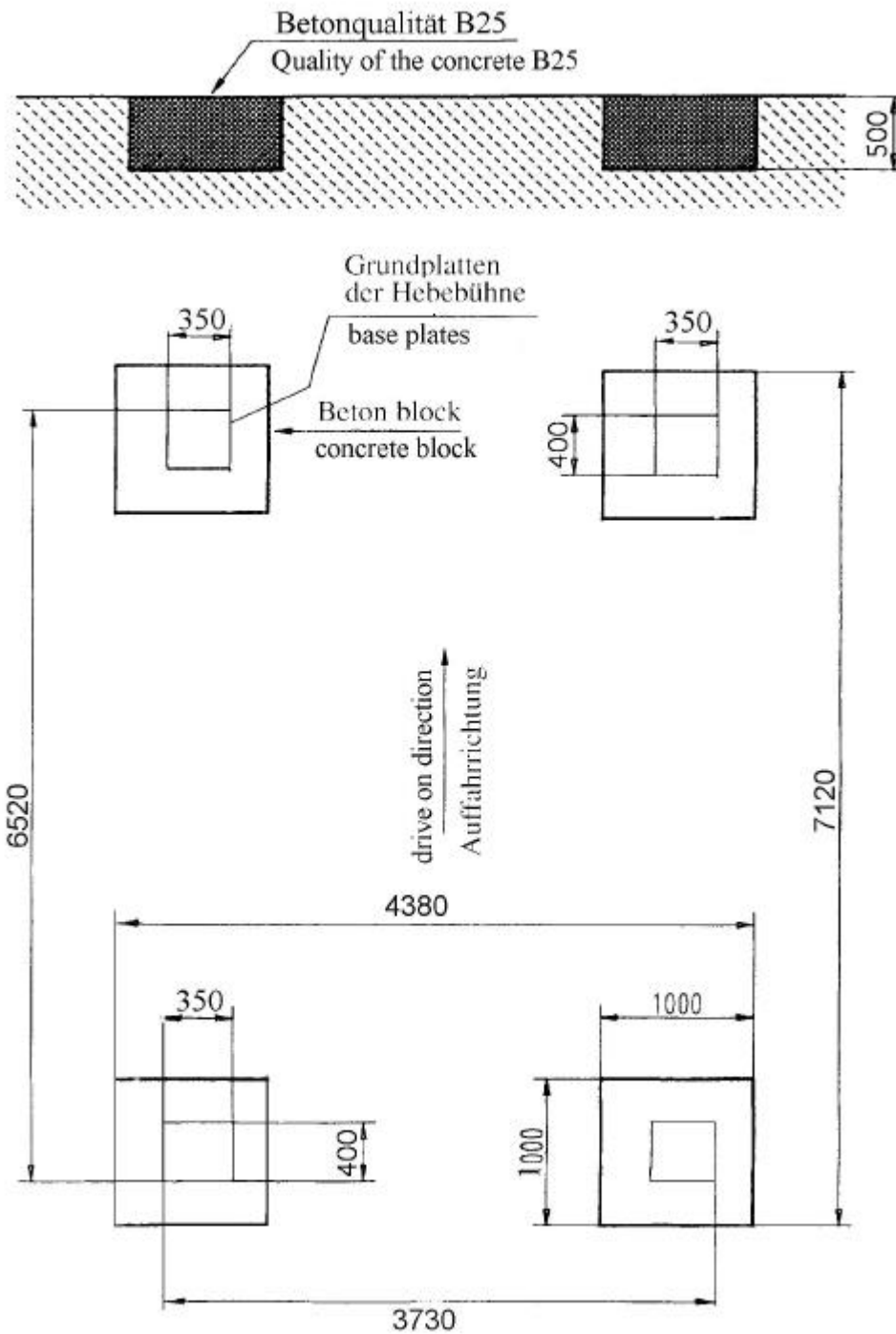

Block foundation: Quality of the concrete: min. B25

Thickness of the block: min. 500 mm

3.5 Hydraulic diagram

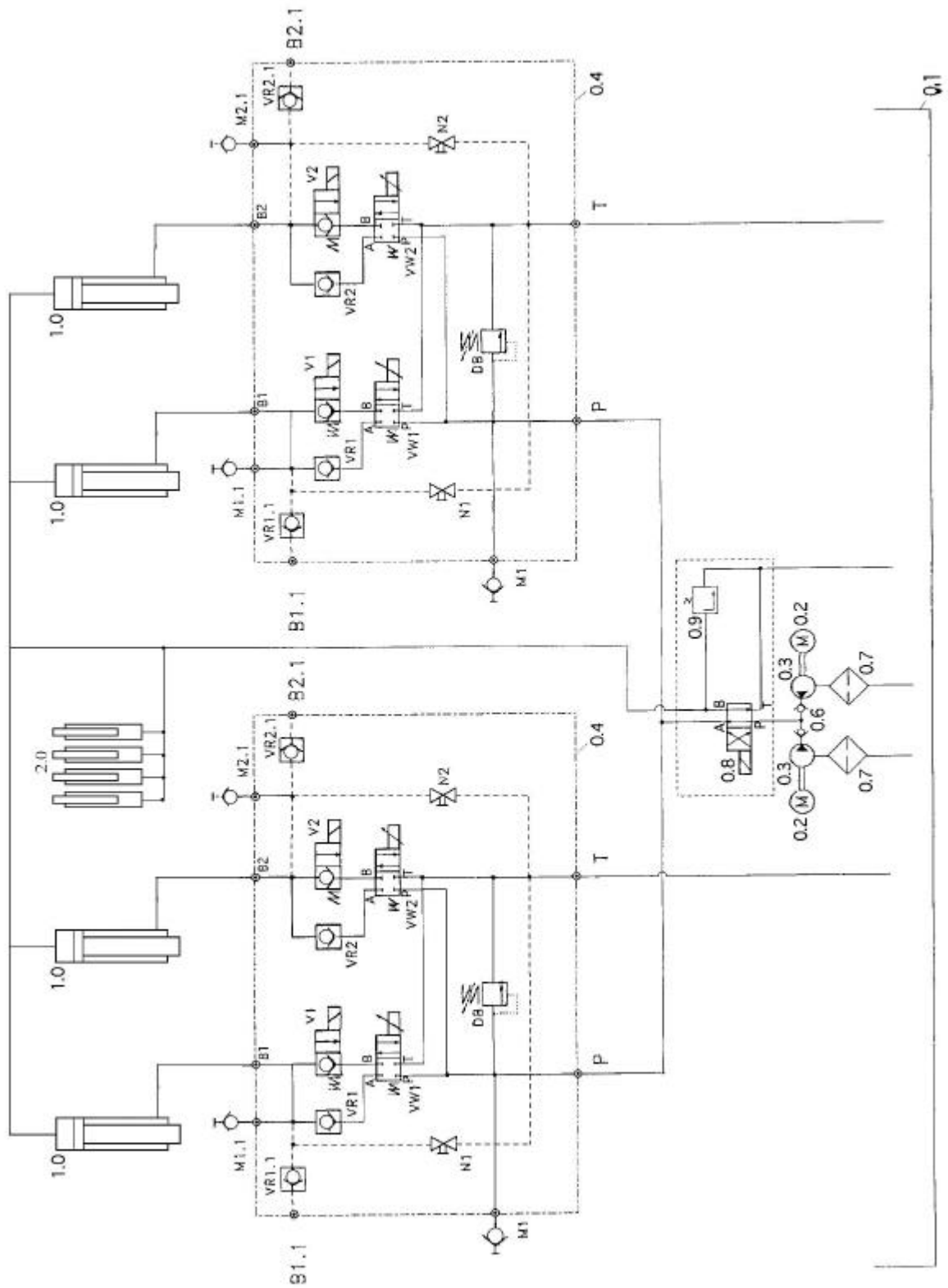

Hydraulic parts list

Nr.	description
0.1	oiltank
0.2	sub oil motor
0.3	gear pump
0.4	oil filter
0.6	holding valve
0.7	oil filter
0.8	4/2 way valve
0.9	pressure control valve (60 bar)
DB	pressure control valve (ca. 270 bar)
N1	emergency lowering screw
N2	emergency lowering screw
M1	measuring connection
M1.1	measuring connection
M2.1	measuring connection
VW1	electrical way valve
VW2	electrical way valve
V1	electrical unlocking holding valve
V2	electrical unlocking holding valve
VR1	holding valve
VR2	holding valve
VR1.1	holding valve
VR2.1	holding valve
B1.1	screw plug
B2.1	screw plug
1.0	Hydraulic cylinder
2.0	Hydraulic cylinder

3.6 Electrical diagram

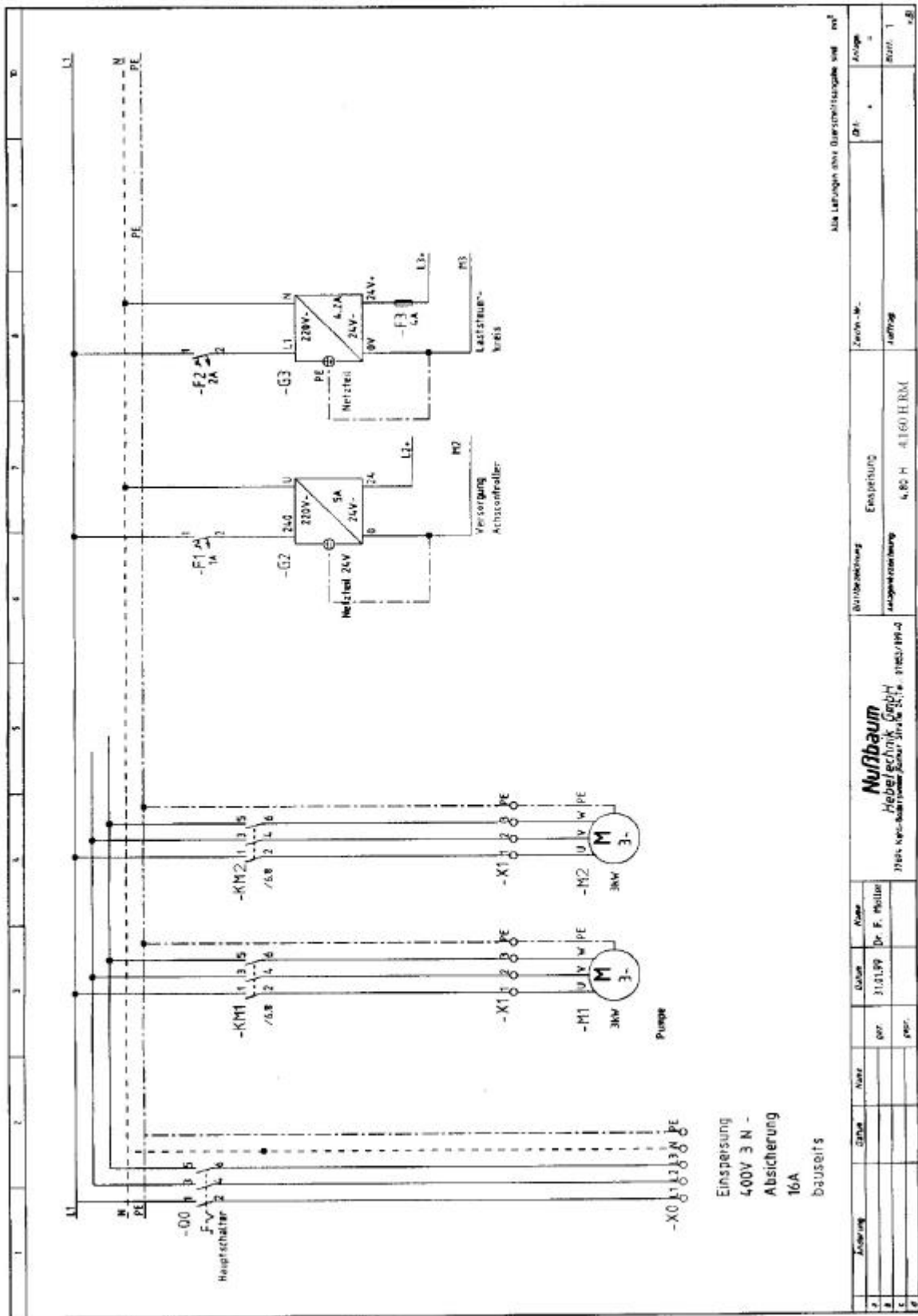

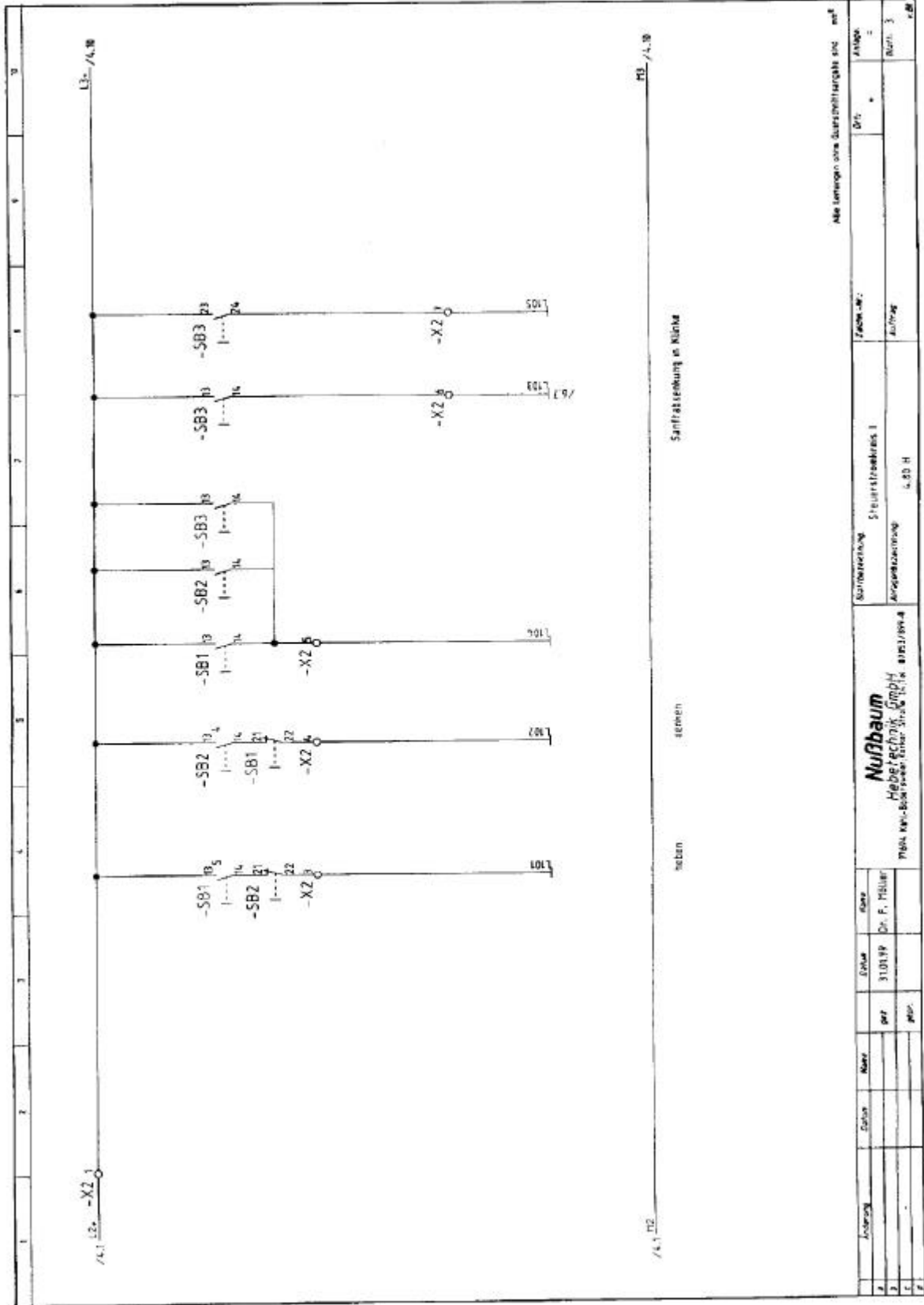

Alle Leistungen sind durchschaltbar und sind mit

Jahresnr.:	Dr.:	Anlage:
Normierung:	Steuerkreis: I	Auftrag:
Anwendung:	4.80 H	Nr. 3
 Nußbaum Hebe-Technik GmbH Mülh. W.-Börseler, Ester. Str. 1, D-41114 Binsfeld		
Datum:	Rev.:	Druck:
		31.01.99
Datum:	Nam.:	Dr. F. Müller

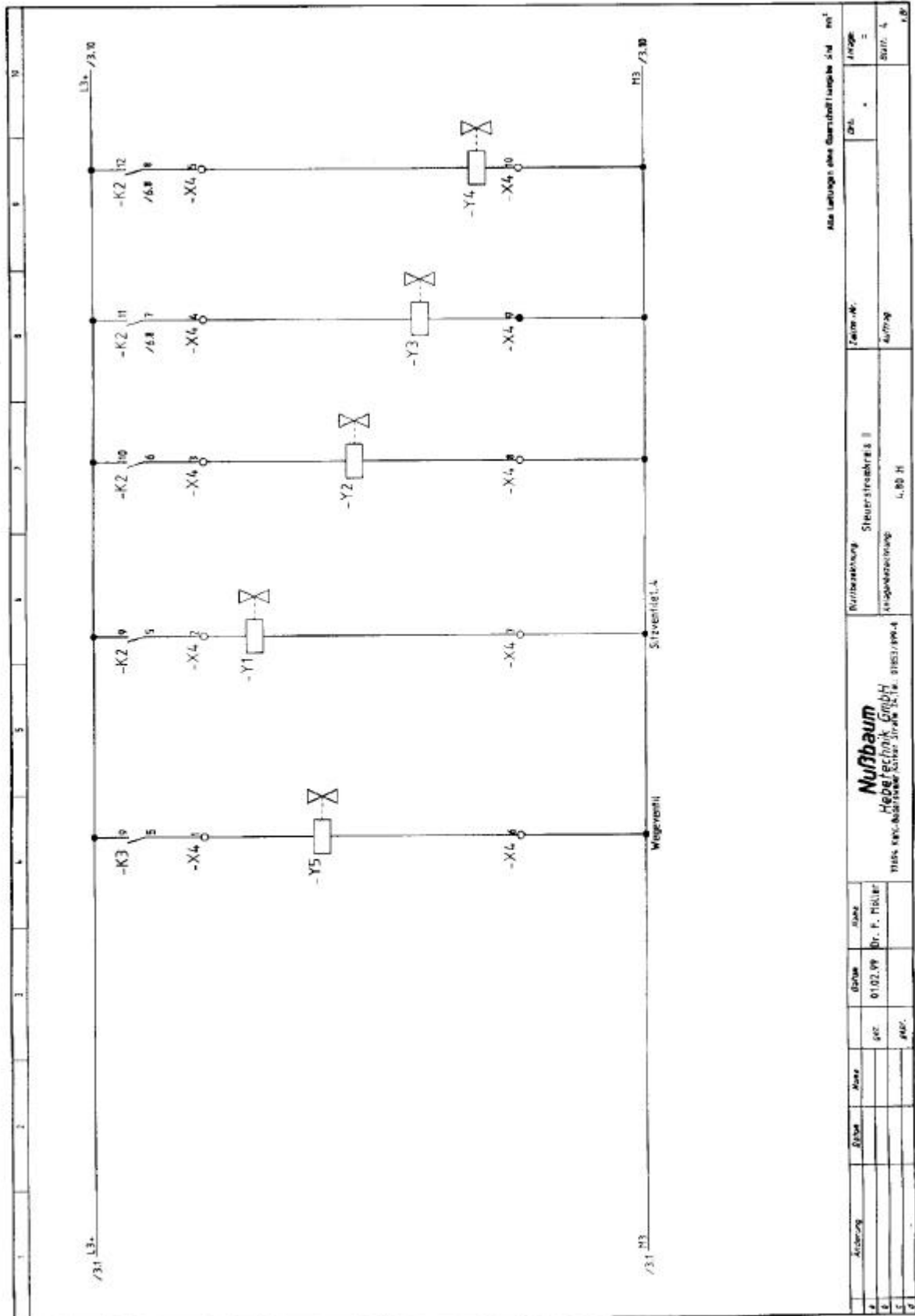

Aufzeichnung		Datum		Dr. F. Müller		Blatt		Anzahl		Menge	
		01.02.99				1/1		2		1	

Alle Leistungen ohne Gewährleistung sind im 1. Blatt

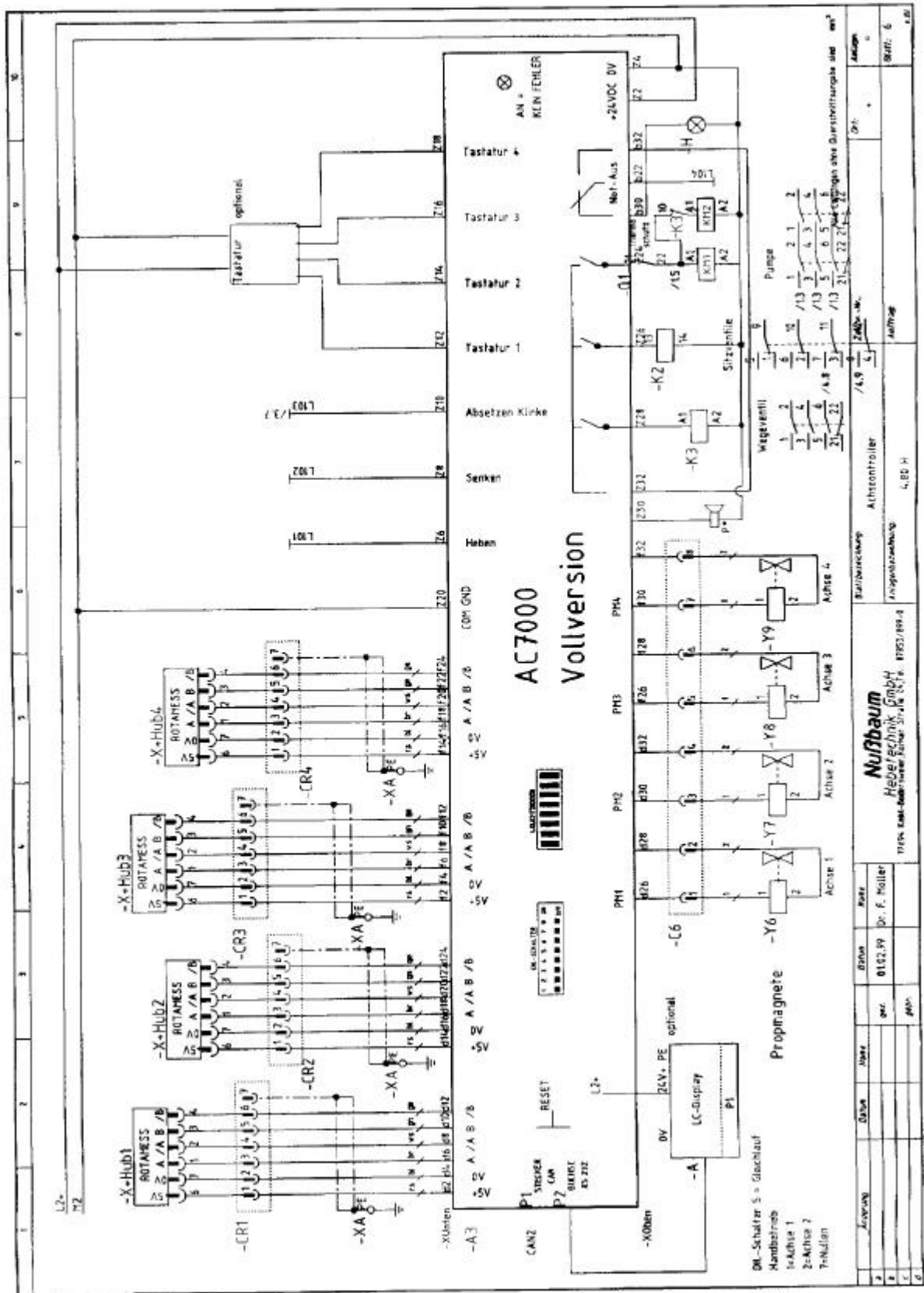

Electrical parts list Teileliste

Q0:	main switch
M1:	motor
M2:	motor
KM1:	up contactor
KM2:	up contactor
SB1:	press button „lifting“
SB2:	press button „lowering“
SB3:	press button „slowly lowering in the ratchet“
K2-K3:	relais
H:	light “obstruction”
P*:	Loudspeaker
G2:	power pack
G3:	power pack
TR:	transformer
GL:	rectifier
F1:	fuse 1 A
F2:	fuse 2 A
F3:	fuse 4 A
Y1:	magnetic valve
Y2:	magnetic valve
Y3:	magnetic valve
Y4:	magnetic valve
Y5:	magnetic valve
Y6:	proportional valve
Y7:	proportional valve
Y8:	proportional valve
Y9:	proportional valve

4. Safety regulations

Using automotive lifts for working the regulations of accident EN1493/Aug.98 (CEN/TC 98 „Automotive lifts”) must be observed.

Especially the following regulations are very important:

- During working with the lift the operating instructions must be followed.
- The laden weight of the lifted vehicle mustn't be more than 8000 kg for automotive lift.
- Only trained personnel over the age of 18 years old are to operate this lift.
- During lifting or lowering the vehicle it must be observed from the operator.
- It's not allowed to stay under the lifted or lowered vehicle (except for the operator).
- It's not allowed to transport passengers on the lift or in the vehicle.
- It's not allowed to climb onto the lift or onto a lifted vehicle.
- The automotive lift must be checked from an expert after changes in construction.
- At vehicles with low underbody-freedom or with optional equipment's, it is to be tested previously whether damages can appear.
- It's not allowed to start with operations at the lift before the main switch is switched off.
- It's not allowed to install the standard-automotive lift in hazardous location.

5. Operating instructions



***The Safety Regulations must be observed during working with the automotive lift.
Read the safety regulations in chapter 4 carefully before working with the lift!***

5.1 Lifting the vehicle

- Drive the vehicle in the automotive lift.
- Block the vehicle against rolling, put into gear.
- Check the dangerous places of the lift and be sure that there are no objects or people in the immediate area of the lift or on the lift.
- Switch on the control system; main switch on position "1" (see pic.1).
- Lift the vehicle on the working height. Press the button „lifting“ .
- Lift the vehicle on the working height.
- Observe the complete process.



pic 1: operating unit

1 main switch

2 Button „Lifting“

3 Button „Lowering“

4 Button „Lowering in the ratchets“

5.2 Lowering the vehicle

- Check the dangerous places of the lift and be sure that there are no objects or people in the immediate area of the lift or on the lift.
- Lower the lift at the height for working or until the carrying arms reach the lowest position.
- Observe the complete process.



- The lift stops approx. 400 mm over the floor. Control the dangerous places of the lift and be sure that there are no objects or people in the immediate area of the lift or on the lift. Press the button “Lowering” until the lift again. You hear an acoustic signal until the lift reaches the lowest position.
- If the lift is in the lowest position, drive the vehicle from the lift.

5.3 Lowering the lift in the ratchet

- Through presses the button „lowering in the ratchet“, the lift is lowering into the next possible ratchet.
- Hold the button pressed until all four security-ratchets are locked and the lift moves no longer downwards.
- To lift the platform out of the ratchets press the button “lifting”.

5.4 Function Microprocessor / Display-ad

- The automotive lift is equipped with a microprocessor. This system recognizes an unequal of the lift and regulate the hydraulic valves until the lift has the same height.

- The processor recognizes the present position of the cylinder. The lift switched off if the automotive lift reaches the top end position or the bottom end position or the position of the ce-stop.
- The display shows the present position of the cylinder.
- this display is required also for the service-business, over a foil-keyboard.

5.5 Driving on an obstacle

- The lift switched off if the lift is running onto an obstacle and out of the rule-window. It is possible through manually operation with the foil-keyboard, to bring the lift into its normal function again. (sees appendix service-business)

6. Troubleshooting

If the lift does not work properly, the reason for this might be quite simple. Please check the lift for the potential reasons mentioned on the following pages. If the cause of trouble cannot be found, please call the technical service.

Problem: The Motor does not start!

- Potential causes:
- *no power supply*
 - *the main switch is not switched on.*
 - *the fuse is defective*
 - *the feed line is cut*
 - *the thermo-fuse is active(let it cool down approx. 10 min.)*
 - *the button "lifting" is not pressed*

Problem: the motor starts, the lift does not lifting!

- Potential causes:
- *the vehicle is too heavy*
 - *the level of the oil is too low*
 - *the emergency lowering screws are not closed*
 - *the hydraulic hoses are dirty*
 - *leakage in the hydraulic-system*

Problem: The lift does not lowered!

- Potential causes:
- *the lift is standing on a obstacle*
 - *the hydraulic valve is defective*
 - *the fuse is defective*
 - *the button "lowering" is not pressed*
 - *the holding valve are not engaged*
 - *the lift is in the ratchet-rods*

6.1 Emergency lowering



A emergency lowering is an intervention into the control of the lift and can be planned only by experienced expert.

The emergency lowering must be carried in this order. Otherwise a malfunction can lead it to damages or lead to danger for body and lives.



Every kind of external leakage must be removed. This is necessary particular before emergency lowering.



In the case of power failure, the emergency-lowering can only enforce if the automotive-lift is not in the safety ratchets. Wait for the end of the blackout.

In this case of defective hydraulic valve, the valves of the lift will not open any more. Therefore the lift can not be lowered. In this case there is the possibility to open the hydraulic valve manually and to lower the lift to it's lowest position, so the vehicle can be driven off.

- Pull back the ratchets manually and lay a suitable support (wood) between the ratchet strip and the ratchet. Or fix the ratchet with the help of a wire. This step should be taken at all four ratchets.
- Remove the cover of the operating unit.

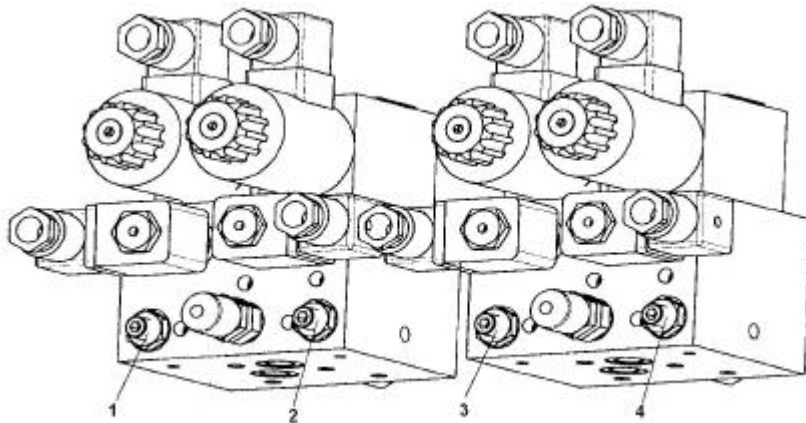

- Open careful the locknuts 1-4 at the hydraulic block. (see pic 2)
- Open max. one turn anticlockwise careful and alternate the emergency lowering screws with a hexagon spanner (5). The destination of a cylinder begins. The lowering of one cylinder starts. Lower the cylinder 5-10 mm and then close the screw.
- Repeat the process at the screws 2 than 3 than 4. Every 5-10 mm until the lift reaches the lowest position.
- If the lift is in the lowest position, close the emergency lowering screws and safe it with the locknut.



Observe the complete emergency-lowering process and close the screws if danger exists.



After finishing the emergency lowering, remove the supports at the ratchets. Otherwise a malfunction of the lift can occur.



To guarantee the safety running of the automotive-lift, the supports must be removed.

7. Maintenance

A regular service has to be performed every three months by the lifts operator according to the following schedule. If the lift is in continuous operation or dirty environment, the maintenance rate has to be increased.

During daily operation the lift has to be watched carefully for its correct function. In case of any malfunction the technical service of the retailer has to be informed.

7.1 Inspection and Maintenance of Nussbaum lifts

Nussbaum lifts have been designed and manufactured for longevity and safe operation. Proper installation and operation, regular inspections and ensuing preventative maintenance by authorised personnel and product care, are the key to operators safety, product reliability, low overall repair costs, qualified warranty claims and finally, longevity of the lift. Our lifts are German TÜV and European CE certified and meet or surpass the safety standards of the countries in which we sell. European regulations for instance, oblige inspection by qualified personnel, every 12 months during the life span of the lift.

Whatever the regulations are in a given country, the following are the minimum, requirements regarding the maintenance of Nussbaum lifts.

1. Product care. On an daily/weekly basis by lift operator

Always contact qualified service personnel whenever there is a safety issue. Check for anomalies at all times in particular after electrical power failure or flooding of the shop floor (check sealing of the canister of in-ground TOP lifts). Execute equalisation procedure of lifts with master/slave system (JUMBO- and UNI-LIFTS). Check for leaky and kicked pipes and hoses. Clean the lift and the floor with a non-aggressive detergent. Prevent corrosion by oiling metallic parts or paint retouch. Check filters, grease/lubrication needs and air pressure. Check condition of lifting pads/polymer supports.

2. Inspection. At least once a year by qualified technician

Safety related:

- Check the proper functioning of all mechanical, electrical, hydraulic and pneumatic safety locking functions

- Check for proper anchoring of the lift to the floor and floor cracks
- Check for potential structural failures, in particular of welded parts
- Check for bending or distortion of mechanical parts

Maintenance related:

- Check for hydraulic/air leaks and condition of pipes/hoses
- Check electrical connections, switches and fuses
- Check for wear of all bearings, hinge points and shafts
- Check condition of lifting pads
- Check for leakage to the in-ground lift canister
- Check for corrosion building

3.Preventative maintenance by qualified technician

- Replace **hydraulic oil** once every year
- Replace **hydraulic hoses** at least once every 6 years
- Take proper **Product care** as recommended in Point 1
- Replace **Safety related** parts whenever there is the slightest doubt
- Replace or repair worn or improper functioning **Maintenance related** parts, before they break down. This avoids costly repairs at a later date

Inspection, repair and maintenance may be done by technicians from Nussbaum, Nussbaum's distributor or end-user. This personnel must be trained on the particular models of lift which they service. They must be able to make a judgement as to the repair or maintenance that needs to be done in order to ensure full safety, operational reliability and structural integrity during the life time of the lift. Proper maintenance records should be kept to back up possible warranty claims.

7.2 Cleaning of the automotive lift

A regular and appropriate maintenance served the preservation of the lift.

It can be a prerequisite for claims at possible corrosion.

The best protection for the lift is the regular cleaning of dirt of all manner.

- Including this:

- de-icing salt
- sand, pebble stone, natural soil
- industrial dust of all manner
- water ; also in connection with other environmental influences
- aggressive deposit of all manner
- constant humidity by insufficient ventilation

How often must the lift be cleaned ?

This is dependent on the use, of the working with the lift, of the cleanness of the workshop and location of the lift. The degree of the dirt is dependent on the season, of the weather conditions and the ventilation of the workshop.

Under bad circumstances it is necessary to clean the lift every week, but a cleaning every month can suffice.

Clean the lift and the floor with a non-aggressive and non-abrasive detergent. Use gentle detergent to clean the parts. Use an standard washing-up liquid and lukewarm water.

- Do not use for cleaning a steam jet cleaning
- Remove all dirt careful with a sponge if necessary with a brush.
- Pay attention that are no remains of the washing-up liquids on the lift after cleaning.
- Do not use aggressive means for cleaning the workshop floor and the automotive lift.
- A permanent contact with every kind of liquid is forbidden. Do not use any high pressure device for cleaning the lift.

8. Security check

The security check is necessary to guarantee the safety of the lifting during use. It has to be performed in the following cases:

1. Before the initial operation, after the first installation
Use the form “First security check before initiation”
2. In regular intervals after the initial operation, at least annually.
Use the form “Regular security check at least annually”
3. Every time the construction of that particular lift has been changed.
Use the form “Extraordinary security check”



The first and the regular security check must be performed by a competent person. It is recommended to service the lift at this occasion.



After the construction of the lift has been changed (changing the lifting height or capacity for example) and after serious maintenance works (welding on carrying parts) an extraordinary security check must be performed by an expert.

This manual contains form with a schedule for the security checks. Please us the adequate form for the security checks. The form should remain in this manual after they have been filled out. In the following there is a short description about special safety devices.

9. Installation and Initiation

9.1 Regulations for the installation

- The installation of the lift is performed by trained technicians of the manufacturer or its distribution partner. If the operator can provide trained mechanics, he can install the lift by himself. The installation has to be done according to this regulation.
- The standard lift must not be installed in hazardous locations or washing areas.
- Before installation a sufficient foundation must be proved or constructed. An even installation place has to be provided. The foundations must be based in a frost resistance depth, both outside and indoors, where you must reckon with frost.
- An electrical supply 3~/N+PE, 400 V, 50 Hz has to be provided (standard version). The supply line must be protected with T16A (VDE0100 German regulation). The minimum diameter amounts to 2,5 mm².
- All cable ducts have to be equipped with protective coverings to prevent accidents.

9.2 Erection and doweling of the lift

It is necessary to dowel the columns at 4 points and to safe the lift against slipping. For this a concrete floor without reinforcement, thickness of 500 mm and quality B 25 is needed. In case of doubt a test drill is necessary and a dowel is to put in. Afterwards the dowel is to fasten with a specified torque (example: Liebig 50 Nm). If the necessary torque is too low or if there are cracks in the concrete floor, a foundation in accordance with the sheet "foundation plan" is to erected. As well it must be paid attention that the installation place is even to guarantee a horizontal erection of the lift.

- Put the runways on two erection trestles at installation place, pay attention of exactly difference between the runways (refer to data sheet).
- Position the crossbeams on the face of the runways.
- Fasten the crossbeams on the runways. Connect the hydraulic tubes.
- Position the columns at the end of the crossbeams.
- Line up operating column (with bubble level) and drill holes for dowel-fixing through four bore-holes of base plates. Clean bore-holes with pressure air. Put in the safety dowels with washers in bore hole.
- Check the position of the lift and the position of the operating column again.
- Bore holes to fix the dowels through the borings of the base plates. Clean holes with pressure air. Put in safety dowels with washers in borings.

The manufacturer demands LIEBIG safety dowels type B 15 (german dowel manufacturer) or equal dowels of another manufacturer (with allowance) but observe their regulations! Before doweling check concrete floor with quality B 25 if the concrete floor goes to the top edge of the floor. In this case the dowels have to be

chosen according to picture 17. If the ground is covered with floor tiles, the dowels have to be chosen according to picture 18.

- Tighten the dowels with the dynamometric key (example Liebig-dowels M = 50Nm)
- Fill in the hydraulic-oil approx. 55 litre.
- Connect the power supply.
- Raise the lift a little. Press the button “lifting”.
- Check the hydraulic tubes of tightness.
- Remove the erection trestles.
- Lower the lift in the lowest position.
- Mount the ratchet rods. Fasten it in the head-plates of the columns.
- Raise the lift. Press the button “lifting”.
- Mount the extension spring at the bottom of the ratchet rods and fasten it in the column.
- Adjust the sliding guidance at the crossbeam (approx. 4-5 mm movement between the sliding guidance and the column).
- Lower the lift in the safety ratchet .
- Adjust the rails with the screws of the ratchet-rod (on the "head-plate" at the top of the column).
- Mount the covers.
- Raise and lower the lift several times with load. Check the torque of the dowels and check the hydraulic parts for tightness.

9.3 Adjusting the rail

The standard measure between the rails is 850 mm. It is possible to adjust the rails +/-100 mm (see the datasheet).

- Lower the lift in the lowest position.
- Drive the vehicle from the lift.
- Rise the lift on the working height and lower it in the ratchets.
- Loose the screws at the runways.
- Adjust the rail.
- Tighten the screw.
- Lift the platform out of the ratches (push button “HEBEN”).
- The lift has the normal function.

9.4 Changing the installation place

If the place of installation shall be changed, the new place has to be prepared in according to the regulations of the first installation. The changing should be performed in accordance with the following points:

- Remove the extension spring at the bottom of the ratchet rods.

- Lower the lift in the lowest position.
- Remove the ratchet rods.
- Remove the cover of the operating unit.
- Raise the lift.
- Lower the on the erection trestles.
- Disconnect the power supply.
- Disconnect the hydraulic tubes.
- Loose the dowels.
- Loose the crossbeams and remove it.
- Transport the lift to the new installation place.
- Install lift in accordance with chapter "Installation and Initiation" of the lift.



Use new dowels, the used dowels can not be used anymore.



A security check must be performed before preoperational by a competent person. Use form "Regular security check".

9.5 Initiation



Before the initiation a security check must be performed (therefore use form: First security check).

If the lift is installed by a competent person, he will perform this security check. If the operator installs the lift by himself, he has to instruct a competent person to perform the security check.

The competent confirms the faultless function of the lift in the installation record and form for the security check and allows the lift to be used.



Please send the filled installation record to the manufacturer after installation.

pic 17: choice of the dowel length without floor pavement or tile surface

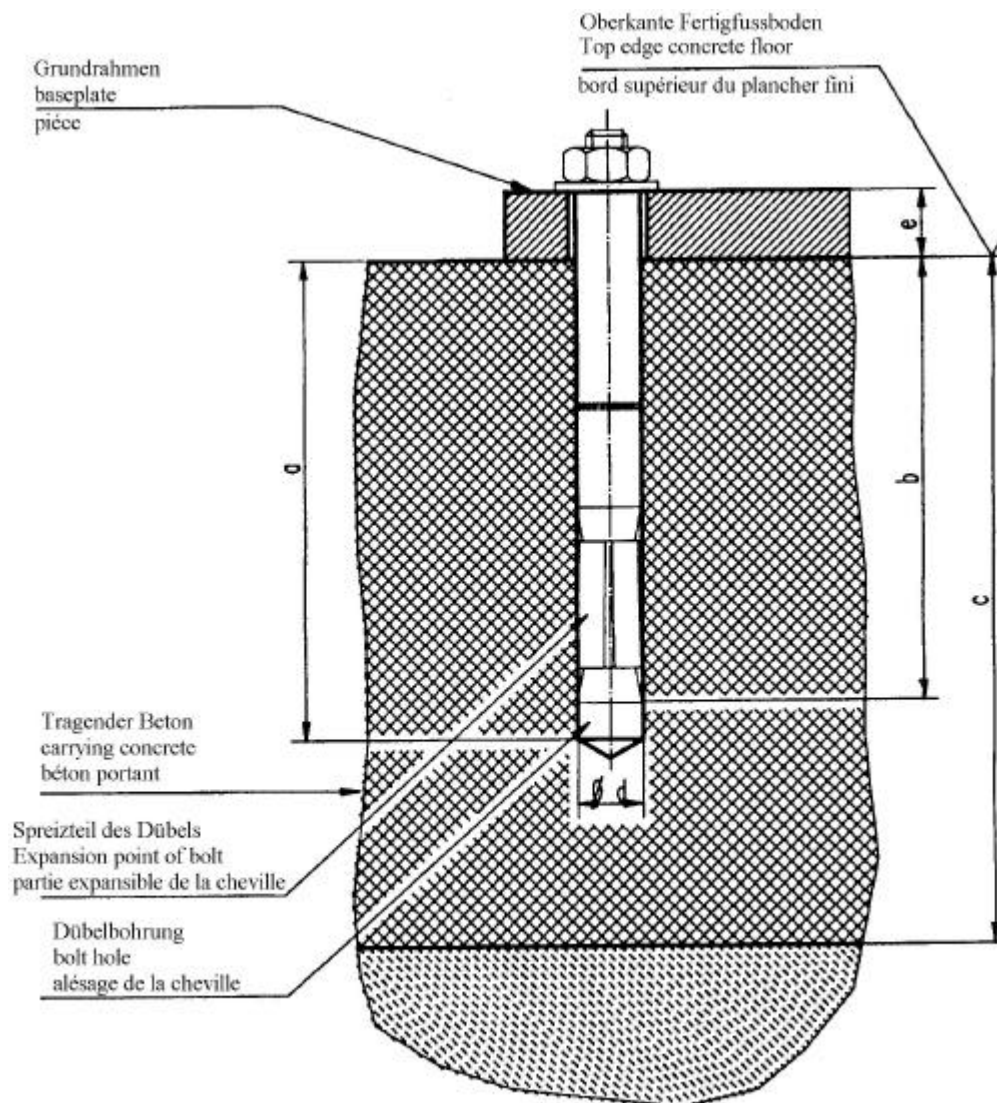

Table to pic. 17

Liebig-dowels

Dowel type		B15/75	B15/95
Drilling depth	a	112	112
Min. anchorage depth	b	72	72
Thickness of concrete	c	160	160
Diameter of bore	d	15	15
Thickness of the lift-pieces	e	0-40	40-65
Number of dowels		16	16
Starting torque		according to dowel manufacturer	



You can use equivalent dowels from another dowel manufacturer (with license) but observe them.

pic 18: choice of the dowel length with floor pavement or tile surface

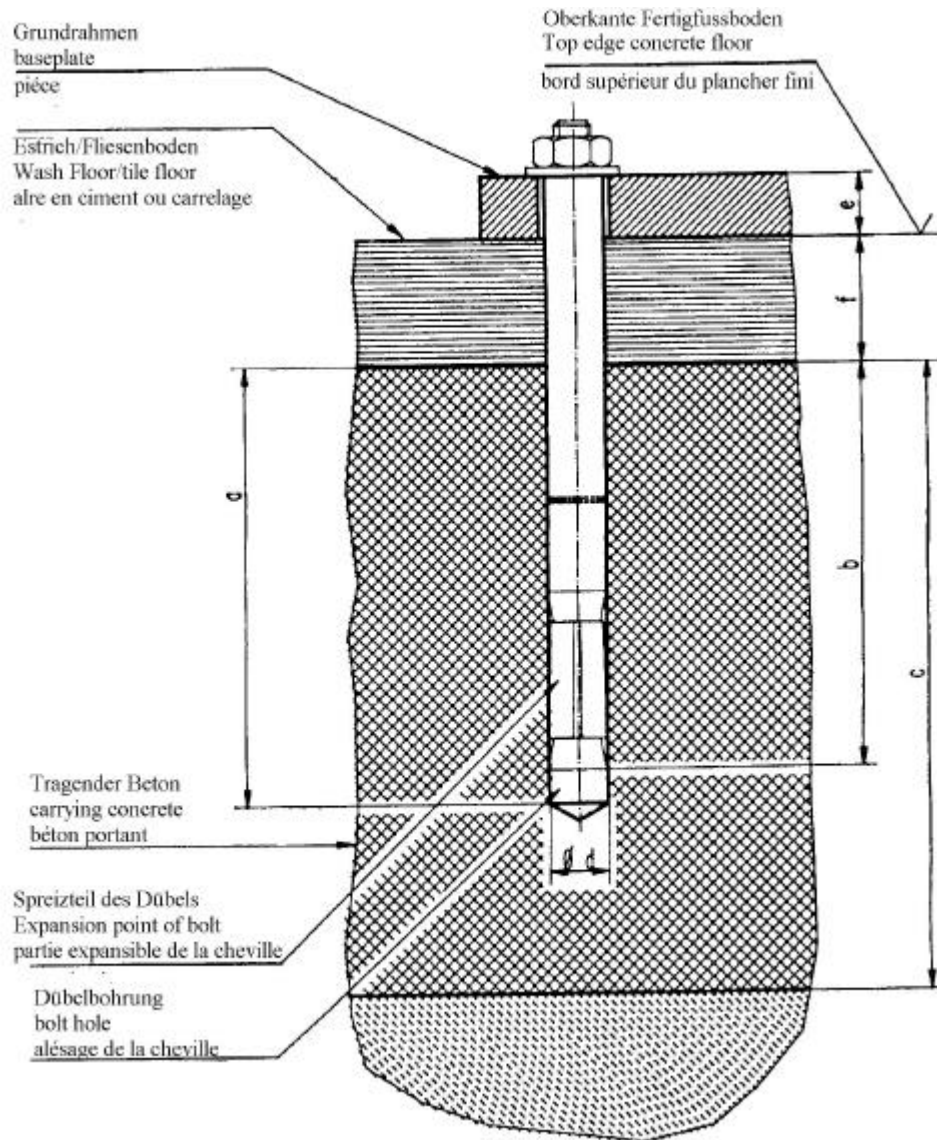

Table to pic. 18

Liebig-dowels

Doweltyp		B15/70	B15/95	B15/120	B15/145
Drilling depth	a	112	137	162	187
Min. anchorage depth	b	72	72	72	72
Thickness of concrete	c	160	160	160	160
Diameter of bore	d	15	15	15	15
Thickness of the lift-pieces	e	0-40	40-65	65-90	90-115
Number of dowels		16	16	16	16
Starting torque		according to dowel manufacturer			



You can use equivalent dowels from another dowel manufacturer (with license) but observe their.

First security check before installation

 Filling out and leave in this manual

kind of check	all right	defect missing	veri- fication	remark
Type plate.....	<input type="checkbox"/>	<input type="checkbox"/>	<input type="checkbox"/>
Short operating instruction.....	<input type="checkbox"/>	<input type="checkbox"/>	<input type="checkbox"/>
Warning designation.....	<input type="checkbox"/>	<input type="checkbox"/>	<input type="checkbox"/>
Designation lifting/lowering.....	<input type="checkbox"/>	<input type="checkbox"/>	<input type="checkbox"/>
Detailed operating instruction.....	<input type="checkbox"/>	<input type="checkbox"/>	<input type="checkbox"/>
Function operating lever.....	<input type="checkbox"/>	<input type="checkbox"/>	<input type="checkbox"/>
Safety device of hinge bolt.....	<input type="checkbox"/>	<input type="checkbox"/>	<input type="checkbox"/>
Condition/Function Ramps.....	<input type="checkbox"/>	<input type="checkbox"/>	<input type="checkbox"/>
Condition automotive lift.....	<input type="checkbox"/>	<input type="checkbox"/>	<input type="checkbox"/>
Securing of bolts.....	<input type="checkbox"/>	<input type="checkbox"/>	<input type="checkbox"/>
Construction (deformation, cracking)	<input type="checkbox"/>	<input type="checkbox"/>	<input type="checkbox"/>
Torque of the dowels	<input type="checkbox"/>	<input type="checkbox"/>	<input type="checkbox"/>
Fixed seat of the screws.....	<input type="checkbox"/>	<input type="checkbox"/>	<input type="checkbox"/>
Condition operating unit.....	<input type="checkbox"/>	<input type="checkbox"/>	<input type="checkbox"/>
Condition surface piston rod	<input type="checkbox"/>	<input type="checkbox"/>	<input type="checkbox"/>
Condition coverings.....	<input type="checkbox"/>	<input type="checkbox"/>	<input type="checkbox"/>
Condition electrical wires	<input type="checkbox"/>	<input type="checkbox"/>	<input type="checkbox"/>
Level of hydraulic oil	<input type="checkbox"/>	<input type="checkbox"/>	<input type="checkbox"/>
Closeness of the hydraulic system.....	<input type="checkbox"/>	<input type="checkbox"/>	<input type="checkbox"/>
Condition hydraulic hoses.....	<input type="checkbox"/>	<input type="checkbox"/>	<input type="checkbox"/>
Function test with vehicle.....	<input type="checkbox"/>	<input type="checkbox"/>	<input type="checkbox"/>
Function safety devices.....	<input type="checkbox"/>	<input type="checkbox"/>	<input type="checkbox"/>
Function/condition ratchets.....	<input type="checkbox"/>	<input type="checkbox"/>	<input type="checkbox"/>
Function/condition slide-guidance.....	<input type="checkbox"/>	<input type="checkbox"/>	<input type="checkbox"/>
Condition runways.....	<input type="checkbox"/>	<input type="checkbox"/>	<input type="checkbox"/>
Condition columns.....	<input type="checkbox"/>	<input type="checkbox"/>	<input type="checkbox"/>

(mark here applicable, in case of verification mark in addition to the first mark!)

Security check carried out:.....

Carried out the company:.....

Name, address of the competent:.....

Result of the Check:

- Initiation not permitted, verification necessary
- Initiation possible, repair failures until.....
- No failings, Initiation possible

.....
signature of the expert

.....
signature of the operator

If failures must be repaired:

Failures repaired at:signature of the operator
(Use another form for verification!)

Regular security check

 Filling out and leave in this manual

kind of check	all right	defect missing	veri- fication	remark
Type plate.....	<input type="checkbox"/>	<input type="checkbox"/>	<input type="checkbox"/>
Short operating instruction.....	<input type="checkbox"/>	<input type="checkbox"/>	<input type="checkbox"/>
Warning designation.....	<input type="checkbox"/>	<input type="checkbox"/>	<input type="checkbox"/>
Designation lifting/lowering.....	<input type="checkbox"/>	<input type="checkbox"/>	<input type="checkbox"/>
Detailed operating instruction.....	<input type="checkbox"/>	<input type="checkbox"/>	<input type="checkbox"/>
Function operating lever.....	<input type="checkbox"/>	<input type="checkbox"/>	<input type="checkbox"/>
Safety device of hinge bolt.....	<input type="checkbox"/>	<input type="checkbox"/>	<input type="checkbox"/>
Condition/Function Ramps.....	<input type="checkbox"/>	<input type="checkbox"/>	<input type="checkbox"/>
Condition automotive lift.....	<input type="checkbox"/>	<input type="checkbox"/>	<input type="checkbox"/>
Securing of bolts.....	<input type="checkbox"/>	<input type="checkbox"/>	<input type="checkbox"/>
Construction (deformation, cracking)	<input type="checkbox"/>	<input type="checkbox"/>	<input type="checkbox"/>
Torque of the dowels	<input type="checkbox"/>	<input type="checkbox"/>	<input type="checkbox"/>
Fixed seat of the screws.....	<input type="checkbox"/>	<input type="checkbox"/>	<input type="checkbox"/>
Condition operating unit.....	<input type="checkbox"/>	<input type="checkbox"/>	<input type="checkbox"/>
Condition surface piston rod	<input type="checkbox"/>	<input type="checkbox"/>	<input type="checkbox"/>
Condition coverings.....	<input type="checkbox"/>	<input type="checkbox"/>	<input type="checkbox"/>
Condition electrical wires	<input type="checkbox"/>	<input type="checkbox"/>	<input type="checkbox"/>
Level of hydraulic oil	<input type="checkbox"/>	<input type="checkbox"/>	<input type="checkbox"/>
Closeness of the hydraulic system.....	<input type="checkbox"/>	<input type="checkbox"/>	<input type="checkbox"/>
Condition hydraulic hoses.....	<input type="checkbox"/>	<input type="checkbox"/>	<input type="checkbox"/>
Function test with vehicle.....	<input type="checkbox"/>	<input type="checkbox"/>	<input type="checkbox"/>
Function safety devices.....	<input type="checkbox"/>	<input type="checkbox"/>	<input type="checkbox"/>
Function/condition ratchets.....	<input type="checkbox"/>	<input type="checkbox"/>	<input type="checkbox"/>
Function/condition slide-guidance.....	<input type="checkbox"/>	<input type="checkbox"/>	<input type="checkbox"/>
Condition runways.....	<input type="checkbox"/>	<input type="checkbox"/>	<input type="checkbox"/>
Condition columns.....	<input type="checkbox"/>	<input type="checkbox"/>	<input type="checkbox"/>

(mark here applicable, in case of verification mark in addition to the first mark!)

Security check carried out:.....

Carried out the company:.....

Name, address of the competent:.....

Result of the Check:

- Initiation not permitted, verification necessary
- Initiation possible, repair failures until.....
- No failings, Initiation possible

.....
signature of the expert

.....
signature of the operator

If failures must be repaired:

Failures repaired at:signature of the operator
(Use another form for verification!)

Regular security check

 Filling out and leave in this manual

kind of check	all right	defect missing	veri- fication	remark
Type plate.....	<input type="checkbox"/>	<input type="checkbox"/>	<input type="checkbox"/>
Short operating instruction.....	<input type="checkbox"/>	<input type="checkbox"/>	<input type="checkbox"/>
Warning designation.....	<input type="checkbox"/>	<input type="checkbox"/>	<input type="checkbox"/>
Designation lifting/lowering.....	<input type="checkbox"/>	<input type="checkbox"/>	<input type="checkbox"/>
Detailed operating instruction.....	<input type="checkbox"/>	<input type="checkbox"/>	<input type="checkbox"/>
Function operating lever.....	<input type="checkbox"/>	<input type="checkbox"/>	<input type="checkbox"/>
Safety device of hinge bolt.....	<input type="checkbox"/>	<input type="checkbox"/>	<input type="checkbox"/>
Condition/Function Ramps.....	<input type="checkbox"/>	<input type="checkbox"/>	<input type="checkbox"/>
Condition automotive lift.....	<input type="checkbox"/>	<input type="checkbox"/>	<input type="checkbox"/>
Securing of bolts.....	<input type="checkbox"/>	<input type="checkbox"/>	<input type="checkbox"/>
Construction (deformation, cracking)	<input type="checkbox"/>	<input type="checkbox"/>	<input type="checkbox"/>
Torque of the dowels	<input type="checkbox"/>	<input type="checkbox"/>	<input type="checkbox"/>
Fixed seat of the screws.....	<input type="checkbox"/>	<input type="checkbox"/>	<input type="checkbox"/>
Condition operating unit.....	<input type="checkbox"/>	<input type="checkbox"/>	<input type="checkbox"/>
Condition surface piston rod	<input type="checkbox"/>	<input type="checkbox"/>	<input type="checkbox"/>
Condition coverings.....	<input type="checkbox"/>	<input type="checkbox"/>	<input type="checkbox"/>
Condition electrical wires	<input type="checkbox"/>	<input type="checkbox"/>	<input type="checkbox"/>
Level of hydraulic oil	<input type="checkbox"/>	<input type="checkbox"/>	<input type="checkbox"/>
Closeness of the hydraulic system.....	<input type="checkbox"/>	<input type="checkbox"/>	<input type="checkbox"/>
Condition hydraulic hoses.....	<input type="checkbox"/>	<input type="checkbox"/>	<input type="checkbox"/>
Function test with vehicle.....	<input type="checkbox"/>	<input type="checkbox"/>	<input type="checkbox"/>
Function safety devices.....	<input type="checkbox"/>	<input type="checkbox"/>	<input type="checkbox"/>
Function/condition ratchets.....	<input type="checkbox"/>	<input type="checkbox"/>	<input type="checkbox"/>
Function/condition slide-guidance.....	<input type="checkbox"/>	<input type="checkbox"/>	<input type="checkbox"/>
Condition runways.....	<input type="checkbox"/>	<input type="checkbox"/>	<input type="checkbox"/>
Condition columns.....	<input type="checkbox"/>	<input type="checkbox"/>	<input type="checkbox"/>

(mark here applicable, in case of verification mark in addition to the first mark!)

Security check carried out:.....

Carried out the company:.....

Name, address of the competent:.....

Result of the Check:

- Initiation not permitted, verification necessary
- Initiation possible, repair failures until.....
- No failings, Initiation possible

.....
signature of the expert

.....
signature of the operator

If failures must be repaired:

Failures repaired at:signature of the operator
(Use another form for verification!)

Regular security check

 Filling out and leave in this manual

kind of check	all right	defect missing	veri- fication	remark
Type plate.....	<input type="checkbox"/>	<input type="checkbox"/>	<input type="checkbox"/>
Short operating instruction.....	<input type="checkbox"/>	<input type="checkbox"/>	<input type="checkbox"/>
Warning designation.....	<input type="checkbox"/>	<input type="checkbox"/>	<input type="checkbox"/>
Designation lifting/lowering.....	<input type="checkbox"/>	<input type="checkbox"/>	<input type="checkbox"/>
Detailed operating instruction.....	<input type="checkbox"/>	<input type="checkbox"/>	<input type="checkbox"/>
Function operating lever.....	<input type="checkbox"/>	<input type="checkbox"/>	<input type="checkbox"/>
Safety device of hinge bolt.....	<input type="checkbox"/>	<input type="checkbox"/>	<input type="checkbox"/>
Condition/Function Ramps.....	<input type="checkbox"/>	<input type="checkbox"/>	<input type="checkbox"/>
Condition automotive lift.....	<input type="checkbox"/>	<input type="checkbox"/>	<input type="checkbox"/>
Securing of bolts.....	<input type="checkbox"/>	<input type="checkbox"/>	<input type="checkbox"/>
Construction (deformation, cracking)	<input type="checkbox"/>	<input type="checkbox"/>	<input type="checkbox"/>
Torque of the dowels	<input type="checkbox"/>	<input type="checkbox"/>	<input type="checkbox"/>
Fixed seat of the screws.....	<input type="checkbox"/>	<input type="checkbox"/>	<input type="checkbox"/>
Condition operating unit.....	<input type="checkbox"/>	<input type="checkbox"/>	<input type="checkbox"/>
Condition surface piston rod	<input type="checkbox"/>	<input type="checkbox"/>	<input type="checkbox"/>
Condition coverings.....	<input type="checkbox"/>	<input type="checkbox"/>	<input type="checkbox"/>
Condition electrical wires	<input type="checkbox"/>	<input type="checkbox"/>	<input type="checkbox"/>
Level of hydraulic oil	<input type="checkbox"/>	<input type="checkbox"/>	<input type="checkbox"/>
Closeness of the hydraulic system.....	<input type="checkbox"/>	<input type="checkbox"/>	<input type="checkbox"/>
Condition hydraulic hoses.....	<input type="checkbox"/>	<input type="checkbox"/>	<input type="checkbox"/>
Function test with vehicle.....	<input type="checkbox"/>	<input type="checkbox"/>	<input type="checkbox"/>
Function safety devices.....	<input type="checkbox"/>	<input type="checkbox"/>	<input type="checkbox"/>
Function/condition ratchets.....	<input type="checkbox"/>	<input type="checkbox"/>	<input type="checkbox"/>
Function/condition slide-guidance.....	<input type="checkbox"/>	<input type="checkbox"/>	<input type="checkbox"/>
Condition runways.....	<input type="checkbox"/>	<input type="checkbox"/>	<input type="checkbox"/>
Condition columns.....	<input type="checkbox"/>	<input type="checkbox"/>	<input type="checkbox"/>

(mark here applicable, in case of verification mark in addition to the first mark!)

Security check carried out:.....

Carried out the company:.....

Name, address of the competent:.....

Result of the Check:

- Initiation not permitted, verification necessary
- Initiation possible, repair failures until.....
- No failings, Initiation possible

.....
signature of the expert

.....
signature of the operator

If failures must be repaired:

Failures repaired at:signature of the operator
(Use another form for verification!)

Regular security check

 Filling out and leave in this manual

kind of check	all right	defect missing	veri- fication	remark
Type plate.....	<input type="checkbox"/>	<input type="checkbox"/>	<input type="checkbox"/>
Short operating instruction.....	<input type="checkbox"/>	<input type="checkbox"/>	<input type="checkbox"/>
Warning designation.....	<input type="checkbox"/>	<input type="checkbox"/>	<input type="checkbox"/>
Designation lifting/lowering.....	<input type="checkbox"/>	<input type="checkbox"/>	<input type="checkbox"/>
Detailed operating instruction.....	<input type="checkbox"/>	<input type="checkbox"/>	<input type="checkbox"/>
Function operating lever.....	<input type="checkbox"/>	<input type="checkbox"/>	<input type="checkbox"/>
Safety device of hinge bolt.....	<input type="checkbox"/>	<input type="checkbox"/>	<input type="checkbox"/>
Condition/Function Ramps.....	<input type="checkbox"/>	<input type="checkbox"/>	<input type="checkbox"/>
Condition automotive lift.....	<input type="checkbox"/>	<input type="checkbox"/>	<input type="checkbox"/>
Securing of bolts.....	<input type="checkbox"/>	<input type="checkbox"/>	<input type="checkbox"/>
Construction (deformation, cracking)	<input type="checkbox"/>	<input type="checkbox"/>	<input type="checkbox"/>
Torque of the dowels	<input type="checkbox"/>	<input type="checkbox"/>	<input type="checkbox"/>
Fixed seat of the screws.....	<input type="checkbox"/>	<input type="checkbox"/>	<input type="checkbox"/>
Condition operating unit.....	<input type="checkbox"/>	<input type="checkbox"/>	<input type="checkbox"/>
Condition surface piston rod	<input type="checkbox"/>	<input type="checkbox"/>	<input type="checkbox"/>
Condition coverings.....	<input type="checkbox"/>	<input type="checkbox"/>	<input type="checkbox"/>
Condition electrical wires	<input type="checkbox"/>	<input type="checkbox"/>	<input type="checkbox"/>
Level of hydraulic oil	<input type="checkbox"/>	<input type="checkbox"/>	<input type="checkbox"/>
Closeness of the hydraulic system.....	<input type="checkbox"/>	<input type="checkbox"/>	<input type="checkbox"/>
Condition hydraulic hoses.....	<input type="checkbox"/>	<input type="checkbox"/>	<input type="checkbox"/>
Function test with vehicle.....	<input type="checkbox"/>	<input type="checkbox"/>	<input type="checkbox"/>
Function safety devices.....	<input type="checkbox"/>	<input type="checkbox"/>	<input type="checkbox"/>
Function/condition ratchets.....	<input type="checkbox"/>	<input type="checkbox"/>	<input type="checkbox"/>
Function/condition slide-guidance.....	<input type="checkbox"/>	<input type="checkbox"/>	<input type="checkbox"/>
Condition runways.....	<input type="checkbox"/>	<input type="checkbox"/>	<input type="checkbox"/>
Condition columns.....	<input type="checkbox"/>	<input type="checkbox"/>	<input type="checkbox"/>

(mark here applicable, in case of verification mark in addition to the first mark!)

Security check carried out:.....

Carried out the company:.....

Name, address of the competent:.....

Result of the Check:

- Initiation not permitted, verification necessary
- Initiation possible, repair failures until.....
- No failings, Initiation possible

.....
signature of the expert

.....
signature of the operator

If failures must be repaired:

Failures repaired at:signature of the operator
(Use another form for verification!)

Regular security check

 Filling out and leave in this manual

kind of check	all right	defect missing	veri- fication	remark
Type plate.....	<input type="checkbox"/>	<input type="checkbox"/>	<input type="checkbox"/>
Short operating instruction.....	<input type="checkbox"/>	<input type="checkbox"/>	<input type="checkbox"/>
Warning designation.....	<input type="checkbox"/>	<input type="checkbox"/>	<input type="checkbox"/>
Designation lifting/lowering.....	<input type="checkbox"/>	<input type="checkbox"/>	<input type="checkbox"/>
Detailed operating instruction.....	<input type="checkbox"/>	<input type="checkbox"/>	<input type="checkbox"/>
Function operating lever.....	<input type="checkbox"/>	<input type="checkbox"/>	<input type="checkbox"/>
Safety device of hinge bolt.....	<input type="checkbox"/>	<input type="checkbox"/>	<input type="checkbox"/>
Condition/Function Ramps.....	<input type="checkbox"/>	<input type="checkbox"/>	<input type="checkbox"/>
Condition automotive lift.....	<input type="checkbox"/>	<input type="checkbox"/>	<input type="checkbox"/>
Securing of bolts.....	<input type="checkbox"/>	<input type="checkbox"/>	<input type="checkbox"/>
Construction (deformation, cracking)	<input type="checkbox"/>	<input type="checkbox"/>	<input type="checkbox"/>
Torque of the dowels	<input type="checkbox"/>	<input type="checkbox"/>	<input type="checkbox"/>
Fixed seat of the screws.....	<input type="checkbox"/>	<input type="checkbox"/>	<input type="checkbox"/>
Condition operating unit.....	<input type="checkbox"/>	<input type="checkbox"/>	<input type="checkbox"/>
Condition surface piston rod	<input type="checkbox"/>	<input type="checkbox"/>	<input type="checkbox"/>
Condition coverings.....	<input type="checkbox"/>	<input type="checkbox"/>	<input type="checkbox"/>
Condition electrical wires	<input type="checkbox"/>	<input type="checkbox"/>	<input type="checkbox"/>
Level of hydraulic oil	<input type="checkbox"/>	<input type="checkbox"/>	<input type="checkbox"/>
Closeness of the hydraulic system.....	<input type="checkbox"/>	<input type="checkbox"/>	<input type="checkbox"/>
Condition hydraulic hoses.....	<input type="checkbox"/>	<input type="checkbox"/>	<input type="checkbox"/>
Function test with vehicle.....	<input type="checkbox"/>	<input type="checkbox"/>	<input type="checkbox"/>
Function safety devices.....	<input type="checkbox"/>	<input type="checkbox"/>	<input type="checkbox"/>
Function/condition ratchets.....	<input type="checkbox"/>	<input type="checkbox"/>	<input type="checkbox"/>
Function/condition slide-guidance.....	<input type="checkbox"/>	<input type="checkbox"/>	<input type="checkbox"/>
Condition runways.....	<input type="checkbox"/>	<input type="checkbox"/>	<input type="checkbox"/>
Condition columns.....	<input type="checkbox"/>	<input type="checkbox"/>	<input type="checkbox"/>

(mark here applicable, in case of verification mark in addition to the first mark!)

Security check carried out:.....

Carried out the company:.....

Name, address of the competent:.....

Result of the Check:

- Initiation not permitted, verification necessary
- Initiation possible, repair failures until.....
- No failings, Initiation possible

.....
signature of the expert

.....
signature of the operator

If failures must be repaired:

Failures repaired at:signature of the operator
(Use another form for verification!)

Regular security check

 Filling out and leave in this manual

kind of check	all right	defect missing	veri- fication	remark
Type plate.....	<input type="checkbox"/>	<input type="checkbox"/>	<input type="checkbox"/>
Short operating instruction.....	<input type="checkbox"/>	<input type="checkbox"/>	<input type="checkbox"/>
Warning designation.....	<input type="checkbox"/>	<input type="checkbox"/>	<input type="checkbox"/>
Designation lifting/lowering.....	<input type="checkbox"/>	<input type="checkbox"/>	<input type="checkbox"/>
Detailed operating instruction.....	<input type="checkbox"/>	<input type="checkbox"/>	<input type="checkbox"/>
Function operating lever.....	<input type="checkbox"/>	<input type="checkbox"/>	<input type="checkbox"/>
Safety device of hinge bolt.....	<input type="checkbox"/>	<input type="checkbox"/>	<input type="checkbox"/>
Condition/Function Ramps.....	<input type="checkbox"/>	<input type="checkbox"/>	<input type="checkbox"/>
Condition automotive lift.....	<input type="checkbox"/>	<input type="checkbox"/>	<input type="checkbox"/>
Securing of bolts.....	<input type="checkbox"/>	<input type="checkbox"/>	<input type="checkbox"/>
Construction (deformation, cracking)	<input type="checkbox"/>	<input type="checkbox"/>	<input type="checkbox"/>
Torque of the dowels	<input type="checkbox"/>	<input type="checkbox"/>	<input type="checkbox"/>
Fixed seat of the screws.....	<input type="checkbox"/>	<input type="checkbox"/>	<input type="checkbox"/>
Condition operating unit.....	<input type="checkbox"/>	<input type="checkbox"/>	<input type="checkbox"/>
Condition surface piston rod	<input type="checkbox"/>	<input type="checkbox"/>	<input type="checkbox"/>
Condition coverings.....	<input type="checkbox"/>	<input type="checkbox"/>	<input type="checkbox"/>
Condition electrical wires	<input type="checkbox"/>	<input type="checkbox"/>	<input type="checkbox"/>
Level of hydraulic oil	<input type="checkbox"/>	<input type="checkbox"/>	<input type="checkbox"/>
Closeness of the hydraulic system.....	<input type="checkbox"/>	<input type="checkbox"/>	<input type="checkbox"/>
Condition hydraulic hoses.....	<input type="checkbox"/>	<input type="checkbox"/>	<input type="checkbox"/>
Function test with vehicle.....	<input type="checkbox"/>	<input type="checkbox"/>	<input type="checkbox"/>
Function safety devices.....	<input type="checkbox"/>	<input type="checkbox"/>	<input type="checkbox"/>
Function/condition ratchets.....	<input type="checkbox"/>	<input type="checkbox"/>	<input type="checkbox"/>
Function/condition slide-guidance.....	<input type="checkbox"/>	<input type="checkbox"/>	<input type="checkbox"/>
Condition runways.....	<input type="checkbox"/>	<input type="checkbox"/>	<input type="checkbox"/>
Condition columns.....	<input type="checkbox"/>	<input type="checkbox"/>	<input type="checkbox"/>

(mark here applicable, in case of verification mark in addition to the first mark!)

Security check carried out:.....

Carried out the company:.....

Name, address of the competent:.....

Result of the Check:

- Initiation not permitted, verification necessary
- Initiation possible, repair failures until.....
- No failings, Initiation possible

.....
signature of the expert

.....
signature of the operator

If failures must be repaired:

Failures repaired at:signature of the operator
(Use another form for verification!)

Regular security check

 Filling out and leave in this manual

kind of check	all right	defect missing	veri- fication	remark
Type plate.....	<input type="checkbox"/>	<input type="checkbox"/>	<input type="checkbox"/>
Short operating instruction.....	<input type="checkbox"/>	<input type="checkbox"/>	<input type="checkbox"/>
Warning designation.....	<input type="checkbox"/>	<input type="checkbox"/>	<input type="checkbox"/>
Designation lifting/lowering.....	<input type="checkbox"/>	<input type="checkbox"/>	<input type="checkbox"/>
Detailed operating instruction.....	<input type="checkbox"/>	<input type="checkbox"/>	<input type="checkbox"/>
Function operating lever.....	<input type="checkbox"/>	<input type="checkbox"/>	<input type="checkbox"/>
Safety device of hinge bolt.....	<input type="checkbox"/>	<input type="checkbox"/>	<input type="checkbox"/>
Condition/Function Ramps.....	<input type="checkbox"/>	<input type="checkbox"/>	<input type="checkbox"/>
Condition automotive lift.....	<input type="checkbox"/>	<input type="checkbox"/>	<input type="checkbox"/>
Securing of bolts.....	<input type="checkbox"/>	<input type="checkbox"/>	<input type="checkbox"/>
Construction (deformation, cracking)	<input type="checkbox"/>	<input type="checkbox"/>	<input type="checkbox"/>
Torque of the dowels	<input type="checkbox"/>	<input type="checkbox"/>	<input type="checkbox"/>
Fixed seat of the screws.....	<input type="checkbox"/>	<input type="checkbox"/>	<input type="checkbox"/>
Condition operating unit.....	<input type="checkbox"/>	<input type="checkbox"/>	<input type="checkbox"/>
Condition surface piston rod	<input type="checkbox"/>	<input type="checkbox"/>	<input type="checkbox"/>
Condition coverings.....	<input type="checkbox"/>	<input type="checkbox"/>	<input type="checkbox"/>
Condition electrical wires	<input type="checkbox"/>	<input type="checkbox"/>	<input type="checkbox"/>
Level of hydraulic oil	<input type="checkbox"/>	<input type="checkbox"/>	<input type="checkbox"/>
Closeness of the hydraulic system.....	<input type="checkbox"/>	<input type="checkbox"/>	<input type="checkbox"/>
Condition hydraulic hoses.....	<input type="checkbox"/>	<input type="checkbox"/>	<input type="checkbox"/>
Function test with vehicle.....	<input type="checkbox"/>	<input type="checkbox"/>	<input type="checkbox"/>
Function safety devices.....	<input type="checkbox"/>	<input type="checkbox"/>	<input type="checkbox"/>
Function/condition ratchets.....	<input type="checkbox"/>	<input type="checkbox"/>	<input type="checkbox"/>
Function/condition slide-guidance.....	<input type="checkbox"/>	<input type="checkbox"/>	<input type="checkbox"/>
Condition runways.....	<input type="checkbox"/>	<input type="checkbox"/>	<input type="checkbox"/>
Condition columns.....	<input type="checkbox"/>	<input type="checkbox"/>	<input type="checkbox"/>

(mark here applicable, in case of verification mark in addition to the first mark!)

Security check carried out:.....

Carried out the company:.....

Name, address of the competent:.....

Result of the Check:

- Initiation not permitted, verification necessary
- Initiation possible, repair failures until.....
- No failings, Initiation possible

.....
signature of the expert

.....
signature of the operator

If failures must be repaired:

Failures repaired at:signature of the operator
(Use another form for verification!)

Regular security check



Filling out and leave in this manual

kind of check	all right	defect missing	veri- fication	remark
Type plate.....	<input type="checkbox"/>	<input type="checkbox"/>	<input type="checkbox"/>
Short operating instruction.....	<input type="checkbox"/>	<input type="checkbox"/>	<input type="checkbox"/>
Warning designation.....	<input type="checkbox"/>	<input type="checkbox"/>	<input type="checkbox"/>
Designation lifting/lowering.....	<input type="checkbox"/>	<input type="checkbox"/>	<input type="checkbox"/>
Detailed operating instruction.....	<input type="checkbox"/>	<input type="checkbox"/>	<input type="checkbox"/>
Function operating lever.....	<input type="checkbox"/>	<input type="checkbox"/>	<input type="checkbox"/>
Safety device of hinge bolt.....	<input type="checkbox"/>	<input type="checkbox"/>	<input type="checkbox"/>
Condition/Function Ramps.....	<input type="checkbox"/>	<input type="checkbox"/>	<input type="checkbox"/>
Condition automotive lift.....	<input type="checkbox"/>	<input type="checkbox"/>	<input type="checkbox"/>
Securing of bolts.....	<input type="checkbox"/>	<input type="checkbox"/>	<input type="checkbox"/>
Construction (deformation, cracking)	<input type="checkbox"/>	<input type="checkbox"/>	<input type="checkbox"/>
Torque of the dowels	<input type="checkbox"/>	<input type="checkbox"/>	<input type="checkbox"/>
Fixed seat of the screws.....	<input type="checkbox"/>	<input type="checkbox"/>	<input type="checkbox"/>
Condition operating unit.....	<input type="checkbox"/>	<input type="checkbox"/>	<input type="checkbox"/>
Condition surface piston rod	<input type="checkbox"/>	<input type="checkbox"/>	<input type="checkbox"/>
Condition coverings.....	<input type="checkbox"/>	<input type="checkbox"/>	<input type="checkbox"/>
Condition electrical wires	<input type="checkbox"/>	<input type="checkbox"/>	<input type="checkbox"/>
Level of hydraulic oil	<input type="checkbox"/>	<input type="checkbox"/>	<input type="checkbox"/>
Closeness of the hydraulic system.....	<input type="checkbox"/>	<input type="checkbox"/>	<input type="checkbox"/>
Condition hydraulic hoses.....	<input type="checkbox"/>	<input type="checkbox"/>	<input type="checkbox"/>
Function test with vehicle.....	<input type="checkbox"/>	<input type="checkbox"/>	<input type="checkbox"/>
Function safety devices.....	<input type="checkbox"/>	<input type="checkbox"/>	<input type="checkbox"/>
Function/condition ratchets.....	<input type="checkbox"/>	<input type="checkbox"/>	<input type="checkbox"/>
Function/condition slide-guidance.....	<input type="checkbox"/>	<input type="checkbox"/>	<input type="checkbox"/>
Condition runways.....	<input type="checkbox"/>	<input type="checkbox"/>	<input type="checkbox"/>
Condition columns.....	<input type="checkbox"/>	<input type="checkbox"/>	<input type="checkbox"/>

(mark here applicable, in case of verification mark in addition to the first mark!)

Security check carried out:.....

Carried out the company:.....

Name, address of the competent:.....

Result of the Check:

- Initiation not permitted, verification necessary
- Initiation possible, repair failures until.....
- No failings, Initiation possible

.....
signature of the expert

.....
signature of the operator

If failures must be repaired:

Failures repaired at:signature of the operator
(Use another form for verification!)

Extraordinary security check

 Filling out and leave in this manual

kind of check	all right	defect missing	veri- fication	remark
Type plate.....	<input type="checkbox"/>	<input type="checkbox"/>	<input type="checkbox"/>
Short operating instruction.....	<input type="checkbox"/>	<input type="checkbox"/>	<input type="checkbox"/>
Warning designation.....	<input type="checkbox"/>	<input type="checkbox"/>	<input type="checkbox"/>
Designation lifting/lowering.....	<input type="checkbox"/>	<input type="checkbox"/>	<input type="checkbox"/>
Detailed operating instruction.....	<input type="checkbox"/>	<input type="checkbox"/>	<input type="checkbox"/>
Function operating lever.....	<input type="checkbox"/>	<input type="checkbox"/>	<input type="checkbox"/>
Safety device of hinge bolt.....	<input type="checkbox"/>	<input type="checkbox"/>	<input type="checkbox"/>
Condition/Function Ramps.....	<input type="checkbox"/>	<input type="checkbox"/>	<input type="checkbox"/>
Condition automotive lift.....	<input type="checkbox"/>	<input type="checkbox"/>	<input type="checkbox"/>
Securing of bolts.....	<input type="checkbox"/>	<input type="checkbox"/>	<input type="checkbox"/>
Construction (deformation, cracking)	<input type="checkbox"/>	<input type="checkbox"/>	<input type="checkbox"/>
Torque of the dowels	<input type="checkbox"/>	<input type="checkbox"/>	<input type="checkbox"/>
Fixed seat of the screws.....	<input type="checkbox"/>	<input type="checkbox"/>	<input type="checkbox"/>
Condition operating unit.....	<input type="checkbox"/>	<input type="checkbox"/>	<input type="checkbox"/>
Condition surface piston rod	<input type="checkbox"/>	<input type="checkbox"/>	<input type="checkbox"/>
Condition coverings.....	<input type="checkbox"/>	<input type="checkbox"/>	<input type="checkbox"/>
Condition electrical wires	<input type="checkbox"/>	<input type="checkbox"/>	<input type="checkbox"/>
Level of hydraulic oil	<input type="checkbox"/>	<input type="checkbox"/>	<input type="checkbox"/>
Closeness of the hydraulic system.....	<input type="checkbox"/>	<input type="checkbox"/>	<input type="checkbox"/>
Condition hydraulic hoses.....	<input type="checkbox"/>	<input type="checkbox"/>	<input type="checkbox"/>
Function test with vehicle.....	<input type="checkbox"/>	<input type="checkbox"/>	<input type="checkbox"/>
Function safety devices.....	<input type="checkbox"/>	<input type="checkbox"/>	<input type="checkbox"/>
Function/condition ratchets.....	<input type="checkbox"/>	<input type="checkbox"/>	<input type="checkbox"/>
Function/condition slide-guidance.....	<input type="checkbox"/>	<input type="checkbox"/>	<input type="checkbox"/>
Condition runways.....	<input type="checkbox"/>	<input type="checkbox"/>	<input type="checkbox"/>
Condition columns.....	<input type="checkbox"/>	<input type="checkbox"/>	<input type="checkbox"/>

(mark here applicable, in case of verification mark in addition to the first mark!)

Security check carried out:.....

Carried out the company:.....

Name, address of the competent:.....

Result of the Check:

- Initiation not permitted, verification necessary
- Initiation possible, repair failures until.....
- No failings, Initiation possible

.....
signature of the expert

.....
signature of the operator

If failures must be repaired:

Failures repaired at:signature of the operator
(Use another form for verification!)

Manual service operation over the keyboard

Activity only for authorized persons.

One foil-keyboard and one LC-Display for the position-ad and the service-operation are integrated in the control-box/operating unit.

1. After switching on the installation, the following ad appears on the display

Nussbaum Hebetechnik

After 5 seconds, one switches automatically to the position-ad.

2. Position-ad

Ad the position of the 4 axes during the normal operation of the lift.

A1-A4: position-value of the 4 axes

A1:	0.0
A2:	0.0
A3:	0.0
A4:	0.0

Step during the business a mistake on, the axis becomes with the mistake through „-E - „in the position-ad marked.

The ad changes between the position-ad and the error message.

Examples:

Ad-statuses with synchronism-mistake of axis 1

A1:	50.3 -E-
A2:	0.0
A3:	0.0
A4:	0.0

Gleichlauffehler

Only when a such mistake was caused, should after telephonic consultation with the Fa. Nussbaum, phone, 0049 (0)7853-899-159, the service-functions, (sees section 4 (service-operating) become used.

With full function-willingness of the automotive-lift, the operating of the service - functions, over the foil-keyboard is forbidden.

3. Elapsed time indicator-ad

The number of the working hours can be extract through the operating. Press the button < * > on the foil-keyboard of the lift.

Ad of the working hours in hours: minute
Only the time is counted, in which the lift actually drives.

<p>Betriebsstunden 000000:00 h</p>
--

The return to the position-ad takes place automatically anuses approximately 15 seconds or through operates of the < * > -button.

Function button:

< * > Return to the position-ad (2).

4. Service-operation

The service operation is used for it, during the initiation (installation) or to do the lift after a disturbance in function again. Only for these two cases, this operating mode of the lift is intended. Is not allowed to activate these functions, if the lift has the normal function. The functions of the service operation can be activated over the foil-keyboard appropriate on the switchbox. To the navigation in the menu system of the service functions serves the buttons:

<*> **menu-point**

<#>**confirms the menu-point**

Through presses and confirming " zurück " you can go back from a submenu into the higher ranking menu again.

4.1 Log-in in the service-operation

The operator must log-in in the service-operation to activate the service-functions. He presses during the position-ad the button # and inputs afterwards SERVICE-PIN. After correct input the PIN takes place automatically the change into the service-main menu.

Retrieval of the password for service-functions

<p>Password - - - -</p>

Default-value of the password is ' 1234 '.

This can be altered with demand over the PC-Software, the new password is secured durably with it in the FRAM of the „Achscntrollers“.

Function button:

<*> Back to the position-ad (2).

<0> ... < 9 > password input

4.2 Service-Menu

Dialed menu-point becomes through > < marked

>Gesteuert<
Achse nullen
Hubhöhe
zurück

Function button:

< * > next menu-point dials

< # > menu-point activates

The menu-point becomes > zurück < activated jumps back this to the position-ad.

4.3 STEERED

Both axes of the lift can be driven individually over the function " GESTEUERT ". The driven axis becomes over "*" "marks and demarcates and after it over „#"“activates. This function can be used only in the disturbance-case!

controlled operation - axis 1 active

1	50.3
2	0.0
3	0.0
4	0.0

The controlled business over the ad-functions is only possible if the dip-switch stands 5 on the "Achskontroller" on "ON"!

If the dip-switch 5 is standing on "OFF", the axe drives over the dip-switch-attitude, independently from the ad-function.

Over the buttons < 1 >, < 2 >, < 3 >, < 4 > is dialed the axes, the steered procedures should become. The dialed axes become on the ad through *X * marks.

If the button < lifting > or < lowering > was pressed afterwards, only the select axe can moved.

! The installation can become destroyed.

Function button:

< * > Abortion and return into the service-menu (4.2)

< 1 > axe 1 activates / deactivates

< 2 > axe 2 activates / deactivates

< 3 > axe 3 activates / deactivates

< 4 > axe 4 activates / deactivates

4.4 Reset of the measuring systems

Over this function, the entire measuring-system of the lift can be put back, (zero). This function is allowed to only after consultation with the service-headquarters of the Fa. Nussbaum (phone) + 49 (0)7853-899-159.

Achse nullen?

Alert message, whether axes should really become reset.

With confirmation of the retrieval with < # > is put down the axes on zero and is jumped back automatically to the position-ad (2) afterwards.

That zeros of the axes is only possible, if the dip-switch 5 on the „Achskontroller“ stands on „ON“.

! The installation can become destroyed.

Function button:

< * > Abortion and return into the service-menu (4.2)

< # > axes becomes on zero favored

4.5 Altitudes restricts

The maximum lifting of the lift can be restricted over the menu-point " HUBHOEHE ".

The indicated value can over the button < 1 > increment and over the button < 0 > decrement becomes. After election of the desired lift, becomes over < # > the value taken on. The submenu was deserted.

The submenu was deserted with the button and the changed value was not stored.

Function button:

< * > **Demolition and return into the service-menu without stores**

< # > store the new value and return into the service-menu

< 1 > Increases the lifting height

< 0 > Reduces the lifting height

4.6 going back

From a submenu, one can come back into the paramount menu again. Press the button "ZURÜCK".