

# 4.80 H SST - 4.300 H SST

Automotive lift date: 10/2003  
Manual date: 24.10.2003

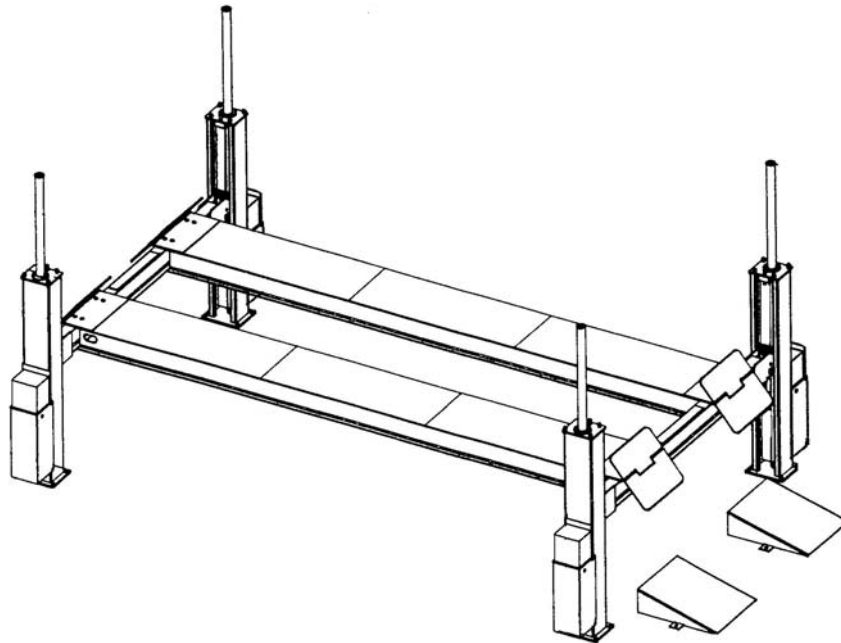

## Operating Instruction and Documentation

Serial number: .....

retailer/ phone



# Nussbaum

Nußbaum Hebetchnik GmbH & Co.KG//Korker Straße 24//D-77694 Kehl-Bodersweier//Tel: +49(0)7853/8990  
Fax: +49 (0)7853/8787//E-mail: info@nussbaum.lifts.de//http://www.nussbaum-lifts.de

## Contents

Foreword .....	3
Record of installation .....	5
Record of handing over .....	6
1.Introduction .....	7
1.1 Installation and check of the automotive lift .....	7
1.2 Information of Warning .....	7
2.Master document of the automotive lift .....	8
2.1 Lift–manufacturer .....	8
2.2 Application.....	8
2.3 Changes at the construction .....	8
2.4 Displacement of the automotive-lift .....	8
2.5 CE-Certificate .....	9
3. Technical Information .....	11
3.1 Technical ratings .....	11
3.2 Safety device.....	11
3.3 Data sheet.....	13
3.4 Foundation diagram drawing .....	14
4. Safety regulations .....	15
5. Operating instructions .....	16
5.1 Lifting the vehicle .....	16
5.2 Lowering the vehicle.....	16
5.3 Equalisation of the Lift .....	17
5.4 Function Microprocessor / Display-advertisement .....	17
5.5 The lift is not in the rule-window .....	17
5.6 Function of the bypass-switch in case of unequal level of the platform.....	17
6.Troubleshooting .....	18
6.1 Driving on an obstacle .....	18
6.1.1 Remove an obstacle .....	19
6.2 Emergency lowering .....	19
6.2.1 Procedure of the emergency lowering .....	19
6.3 Reset the lift after an emergency lowering .....	21
7.Inspection and Maintenance of Nussbaum lifts .....	22
7.1 Maintenance plan of the Mobile column lift.....	22
7.2 Cleaning of the Mobile column lift.....	23
8.Security check .....	24
9.Handing over and Initiation.....	24
9.1 Regulations .....	24
9.3 Adjusting the rail.....	26
9.4 Changing the installation place .....	26
9.5 Initiation .....	27
First security check before installation .....	30
Hydraulic diagram drawing .....	44
Electrical diagram drawing .....	46

## Foreword

Nussbaum-Lifts are a result of long-standing experiences.

The high quality and the superior concept guarantee them reliability, a long lift time and the economic business.

To avoid unnecessary damages and dangers, read the operating instruction attentive and observe the contents.

Another or the described purpose going out use is not valid when not as agreed.

This is valid particularly for climb and go.

*Company Nussbaum is not liable for damages arising from this. The user carries the risk a lonely.*

### For the use belonged:

- to observe all the notice in the operating instruction and
- the following of the inspection and maintenance work and the prescribed tests.
- The instruction for use have to be observed by all persons working with the lift.
- Especially the chapter "Safety/accident Prevention" has to be observed.
- In addition to the safety remarks of the instructions for use the regulations and instructions being valid at the place of operation have to be considered.

### Obligations of the operator:

The operator is obliged to allow only those persons complying to the following requirement to work at the unit

- being well acquainted with the basic regulations concerning labour safety and accident prevention and being trained to operate the unit.
- having read and understood the chapter concerning safety and warning instructions and confirmed that by their signature.

### Dangers when operating with the lift:

The Nussbaum-Lifts are designed and built according to technical standard and the approved regulations for technical security. Yet, danger for body and life of the operator may turn up when using the lift inexpertly.

### The lift must only be operated :

- for its appropriate use
- in unobjectionable condition concerning technical security.

## **Organising requirements**

- The instructions for use are constantly to be kept at the place of operation being at hand at any time.
- In addition to the instructions for use rules pertaining to other regulations i.e. accident prevention and environmental rules are to be observed and directed.
- Safety- and danger alert operation of personal is occasionally and by observing the instructions for use to be controlled.
- As far as required and ordered by regulations personal protective equipment is to be used
- All safety- and danger-hints at the lift are to be observed!
- Spare parts must comply with technical requirements laid down by the manufacturer. This is only warranted with original parts.  
Consider time intervals given or fixed in instructions for use for repeated tests/inspections.

## **Maintenance works, remedy of faults and disposal**

- Fixed Adjusting-, maintenance- and inspection works and time intervals including Details for exchange of parts/part components as mentioned in the instructions for use are to be adhered.  
These works must only be carried out by expert personal.
- After maintenance- and repair works loose screw connections must always be firmly tightened!

## **Guarantee and liability**

- Our “General conditions of selling and delivering” are in force.  
There will be no guarantee or liability for incidents involving injuries or death or damage to equipment if these incidents are the result of one or more of the following reasons.
- Inappropriate use of the lift
- Inappropriate installation, initiation, operation and maintenance of the lift.
- Use of the lift while one or several security devices do not work, do not work correctly or are not installed correctly.
- Failure to follow the regulations of the operating instructions regarding transport, storage, installation, initiation, operation and maintenance of the lift.
- Unauthorized changes to the structure of the lift without first asking the producer.
- Unauthorized changes of adjustments of important components of the lift (e.g. driving elements, power rating, motor speed, etc)
- Wrong or incorrect maintenance practice.
- Catastrophes, acts of God or external reasons.



*Filling out and undersigned and copying this sheet and send the original to the lift manufacturer. The copy remains in the Manual.*

**Otto Nussbaum Hebetchnik GmbH & Co. KG**

**Korker Straße 24**

**D-77694 Kehl-Bodersweier**

## Record of installation

The automotive lift 4.80 H SST – 4.300 H SST with the  
serial number:..... was installed on:.....  
at the firm:..... at:.....  
the safety was checked and the lift was started.

The installation was effected from the operating authority/competent (please delete as applicable).

The safety of the automotive lift was checked from the competent before the initial operation.

The operating authority attest the installation of the automotive lift, the competent attest the correct initial operation.

.....  
date name of the operating authority signature of the operating authority

.....  
date name of the competent person signature of the competent person

Service partner:.....

## Record of handing over

The automotive lift 4.80 H SST – 4.300 H SST with the  
serial number:..... was installed on:.....  
at the firm:..... at:.....  
the safety was checked and the lift was started.

The persons below were introduced after the installation of the automotive lift. The  
introduction was carried out from an erector of the lift-manufacturer or from a franchised  
dealer (competent person).

.....  
date name signature

.....  
date name signature

.....  
date name signature

.....  
date name signature

.....  
date name signature

.....  
date name signature

.....  
date name of competent signature of the competent

Service partner:.....

## 1.Introduction

The document **”Operating Instructions and Documentation”** contains important information about installation, operation and maintenance of the automotive lift.

To furnish proof of **installation of the automotive lift** the form **”Record of Installation”** must be signed and returned to the manufacturer.

To furnish proof of the singular, felt this documentation contains forms. The forms should be used to document the checks. They should not be removed from this documentation.

Every **Changes to the construction** and **displacement** of the automotive lift must be registered in the **”Master document”** of the lift.

### 1.1 Installation and check of the automotive lift

Only specialist staff is allowed to do work concerning safety and to do the safety checks of the lift. They are called experts and competent person in this document.

**Experts** are persons (for example self-employed engineers, experts) which have received instruction and have experience to check and to test automotive lifts. They know the relevant labour and accidents prevention regulations.

**Competent person** are persons who have acquired adequate knowledge and experience with automotive lifts. They took part in training from the lift-manufacturer (servicing technicians of the manufacturer or dealer, are competent)

### 1.2 Information of Warning

To show danger and to show important information the three symbols below are used. Pay attention to those passages, which are marked with these symbols



***Danger! This sign indicates danger to life. Inexpert handling of the described operation may be dangerous to life.***



***Caution! This sign cautions against possible damage to the automotive lift or other material defects in case of inexpert handling .***



***Attention! This sign indicates for an important function or other important notes.***

## 2. Master document of the automotive lift

### 2.1 Lift–manufacturer

Otto Nußbaum Hebetchnik GmbH & Co. KG  
Korker Straße 24  
D-77694 Kehl-Bodersweier  
Germany

### 2.2 Application

The automotive lift 4.80 H SST – 4.300 H SST is a lifting mechanism for lifting motor vehicles with a laden weight of up to 8000 kg – 30.000 kg. The max. load distribution 2:1 in or against drive-on direction. The automotive lift is only designed for service at the vehicles. It is not allowed to carry persons with the lift.

It's not allowed to install the standard-automotive lift in a hazardous location or washing bays.

### 2.3 Changes at the construction

**Changes at the construction, expert checking, resumption of work** (date, kind of change, signature of the expert)

.....  
.....  
.....  
.....

name, address of the expert

.....  
place, date

.....  
signature of the expert

### 2.4 Displacement of the automotive-lift

**Displacement of the automotive-lift, expert checking, resumption of work** (date, kind of change, signature of the competent)

.....  
.....

name, address of the competent

.....  
place, date

.....  
signature of the competent



## 2.5 CE-Certificate

# ZERTIFIKAT CERTIFICATE

## RWTÜV

Registrier-Nr./Registered No.:

**04 205-1063/03**

**EG-Baumusterbescheinigung gemäß Anhang VI der EG-Richtlinie 98/37/EG**  
*EC type-examination certificate according to annex VI of the EC-Directive 98/37/EC*

Zeichen des Auftraggebers Reference of applicant	Auftragsdatum Date of application	Aktenzeichen File reference	Prüfbericht Nr. Test report No.	Ausstellungsdatum Date of issue
Hr. Hassler	28.04.2003	2.4-462/03	1060/03, 1061/03, 1062/02	12.05.2003

Hiermit wird bestätigt, dass das nachfolgend genannte Produkt den grundlegenden Anforderungen der Richtlinie des Rates vom 22.06.98 zur Angleichung der Rechts- und Verwaltungsvorschriften der Mitgliedstaaten über Maschinen entspricht.  
*We hereby certify that the product mentioned below meets the basic requirements of the council directive dated 22.06.98 on the approximation of the laws, regulations and administrative provisions of the member states relating to machinery.*

# CE 0044

**Antragsteller**  
*Applicant:* Otto Nußbaum GmbH & Co. KG  
Korker Str. 24, D-77694 Kehl-Bodersweiher

**Fertigungsstätte:**  
*Manufacturing plant:* s.o.

**Produktbeschreibung:** Kfz-Hebebühne (*carlifter*) Typ: 4...H SST  
*Product description:* Typenschlüssel siehe Anlage 1 (*type code refer annex 1*)

*i.v. G. G. G.*

Zertifizierungsstelle der RWTÜV  
Systems GmbH  
Prüfstelle für Gerätesicherheit und  
Medizinprodukte, notifiziert bei der  
EG-Kommission unter Nr. 0044

RWTÜV Systems GmbH  
Sitz: Essen  
Langemarckstr. 20  
D-45141 Essen  
Postfach 10 32 61  
D-45032 Essen  
Telephone +49/201 8 25-0  
Telefax +49/201 8 25-3209

# ZERTIFIKAT CERTIFICATE RWTÜV

Registrier-Nr./Registered No.:  
**04 205-1063/03**

Anlage 1, Blatt 1 von 1  
Annex 1, page 1 of 1

Zeichen des Auftraggebers Reference of applicant	Auftragsdatum Date of application	Aktenzeichen File reference	Prüfbericht Nr. Test report No.	Ausstellungsdatum Date of issue	Revision Revision
Hr. Hassler	28.04.2003	2.4-462/03	1060/03, 1061/03, 1062/03	12.05.2003	0

**Typbezeichnung:** Kfz-Hebebühne (carlifter) Typ: 4.80H SST  
**Type:** Nennlast (nominal load): 8000 kg

**Typbezeichnung:** Kfz-Hebebühne (carlifter) Typ: 4.100H SST  
**Type:** Nennlast (nominal load): 10000 kg

**Typbezeichnung:** Kfz-Hebebühne (carlifter) Typ: 4.120H SST  
**Type:** Nennlast (nominal load): 12000 kg

i.V. 

Zertifizierungsstelle der RWTÜV  
Systems GmbH  
für Gerätesicherheit und Medizinprodukte,  
notifiziert bei der EG-Kommission unter Nr. 0044

RWTÜV Systems GmbH  
Sitz: Essen  
Langemarckstr. 20  
D-45136 Essen  
Postfach 10 32 61  
D-45032 Essen  
Telephone +49/201 8 25-0  
Telefax +49/201 8 25-3209

## 3. Technical Information

### 3.1 Technical ratings

Capacity:	*after implementation 8000 kg - 30.000 kg
Lifting time	approx. 100 sec. with load (*)
Lowering time	approx. 55 sec. with load
Line voltage	3 x 400 Volt , 50Hz
Control voltage	24 V
Power rating	1,5 kW
Motor speed	1400 rotation/min
Pump capacity	3 cm <sup>3</sup>
Hydraulic pressure	approx. 220 bar with load
Pressure relief valve	approx. 250 bar with load
Pressure relief valve (safety device)	max. 35 bar
Oil tank	approx. 17 L per hydraulic unit
Sound level	≤ 75 dB(A)
Connection by customer (standard)	3~/N+PE, 400V, 50 Hz with fuse T16A (Pay attention to the tension of your state)

### 3.2 Safety device

1. Pressure relief valve  
Overprint-safety of the hydraulic system
2. Holding valve  
safety device against unintentional lowering
3. Lockable main switch  
safety device against unauthorised operation
4. CE-STOP  
safety device against squeeze
5. Hydraulically unlocking safety-system at the cylinder  
Safety device against unintentional lowering
6. Safety Star System (SST)
  - The SST observed the complete Process of the Lift during „Lifting“ and „Lowering“.
  - The lift will be lowering during the normal work with 0,05 Meter per sec.



If the lift descends noticeable faster there may be a problem with the hydraulic system. The computer-control-system recognizes the problem and switch off the hydraulic supply for the cylinder.

The Safety-star system locks and the lift stopped.

- Switch off the main switch.
- Check the complete hydraulic system. If the system is defective, call the service of your retailer.
- The lift can be repaired by an expert, the satisfactory knowledge and experiences with hydraulic ramps has.

## **CE-STOP (main lift and wheel free lift)**

- The automotive lift stops automatically approx. 320 mm before the lowest position.
- Check the dangerous places of the lift and be sure that there are no objects or people in the immediate area of the lift or on the lift.
- An acoustic signal is heard until the lift is in the lowest position

## **Top-Limit**

- The Computer-control-system recognizes the top-height position of the lift and switch off.

## 3.3 Data sheet

Allgemeine Daten  
Data

	Z Gesamt- länge mm length	Y	M Minimale Aufrichthöhe mm height	Schienslänge* plattform = 820 mm = flange „X“
4.100 H SST	7225	3730	250	6000*
4.120 H SST	7225	3730	250	6000*
4.160 H SST	9160	3845	280	8000*
4.200 H SST	9160	3845	280	8000*
4.250 H SST	9500	4200	330	8500*
4.300 H SST	9500	4200	330	8500*

Schiensonderlänge möglich ▶ bei Bestellung unbedingt angeben  
extra length possible ▶ must be indicated with the order

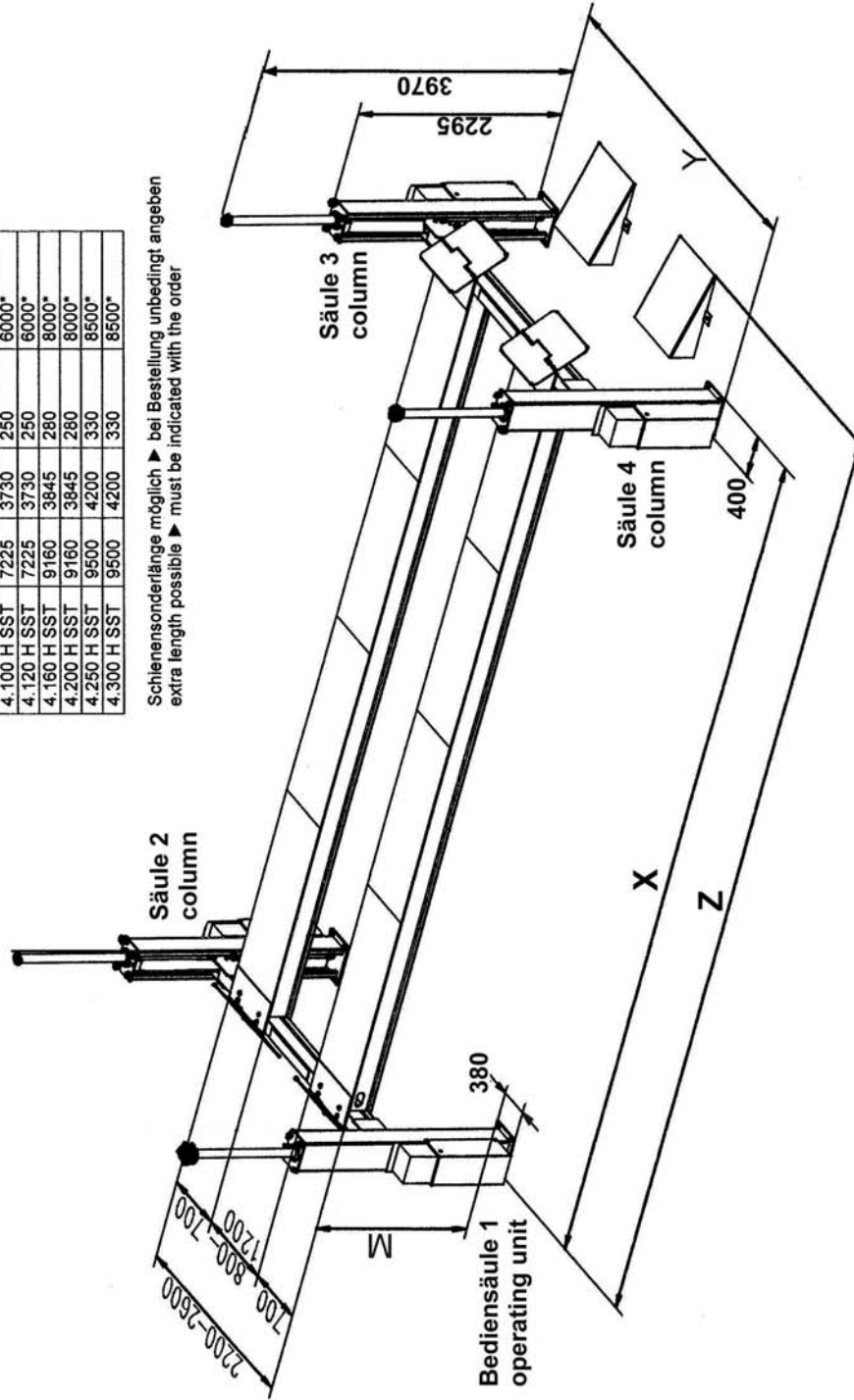

## 3.4 Foundation diagram drawing

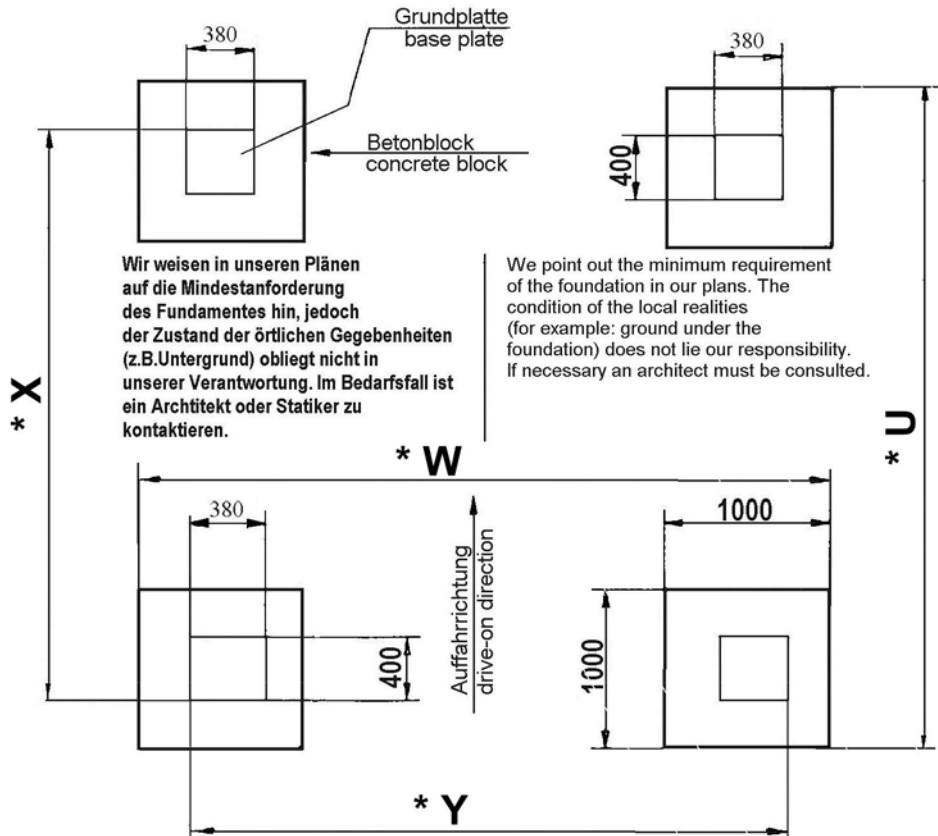
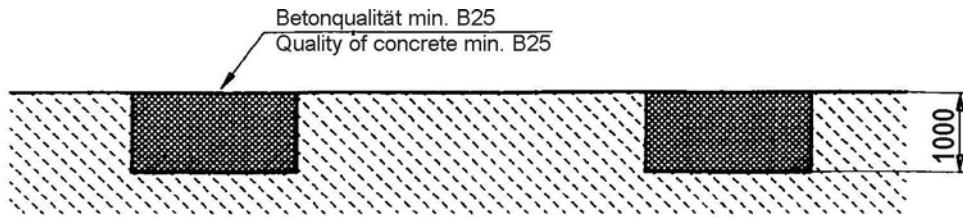

### Fundament Foundation

\* Die Maße können sich je nach Auftrag ändern.  
In according to order, the dimensions can change.

	U	Y	W	Schienenlänge* platform* + 620 mm = Mass „X“
4.100 H SST	7120	3730	4350	6000*
4.120 H SST	7120	3730	4350	6000*
4.160 H SST	9120	3845	4465	8000*
4.200 H SST	9120	3845	4465	8000*
4.250 H SST	9620	4200	4820	8500*
4.300 H SST	9620	4200	4820	8500*

**Bei Erstellung des Fundamentes ist die unbedingt die Schienenlänge zu prüfen.  
Check the length before construction the foundation.**

## 4. Safety regulations

Using automotive lifts for working the regulations of accident EN1493/Aug.98 (CEN/TC 98 „Automotive lifts”) must be observed.

### **Especially the following regulations are very important:**

- During working with the lift the operating instructions must be followed.
- The laden weight of the lifted vehicle mustn't be more than 8000 kg – 30.000 kg for automotive lift
- Only trained personnel over the age of 18 years old are to operate this lift.
- During lifting or lowering the vehicle it must be observed from the operator.
- It's not allowed to stay under the lifted or lowered vehicle (except for the operator).
- It's not allowed to transport passengers on the lift or in the vehicle.
- It's not allowed to climb onto the lift or onto a lifted vehicle.
- The automotive lift must be checked from an expert after changes in construction.
- At vehicles with low under body-freedom or with optional equipment's, it is to be tested previously whether damages can appear.
- It's not allowed to start with operations at the lift before the main switch is switched off.
- It's not allowed to install the standard-automotive lift in hazardous location.

## 5. Operating instructions



*The Safety Regulations must be observed during working with the automotive lift.  
Read the safety regulations in chapter 4 carefully before working with the lift!*

### 5.1 Lifting the vehicle

- Drive vehicle over the lift, longitudinal axes on line of the lift.
- Block the vehicle against rolling, put into gear.
- Check the dangerous places of the lift and be sure that there are no objects or people in the immediate area of the lift or on the lift.
- Switch on the control system; main switch on position "1" (see pic.1)
- Raise the lift. Press the button „lifting“.
- Lift the vehicle on the working height
- In the display of the operating unit, the momentary height of the platform can be read.
- Observe the complete process.



*Pic 1: Operating unit*

- 1 Button „Lifting“
- 2 Button „Lowering“
- 3 Button „equalization the platform“
- 4 Lighting switch
- 5 Keyboard and Display
- 6 Main switch

### 5.2 Lowering the vehicle

- Check the dangerous places of the lift and be sure that there are no objects or people in the immediate area of the lift or on the lift.
- Lower the vehicle to the working height or until the platform reaches the lowest point; press the button „lowering“ .  
The lift is raising a few millimetre before the lift lowered (the safety device is unlocking).
- Observe the complete process.



*The lift stops before reaching the lowest position CE-Stop).*



*Control the dangerous places of the lift and be sure that there are no objects or people in the immediate area of the lift or on the lift. Press the button “Lowering” until the lift again. You hear an acoustic signal until the lift is reaching the lowest position.*

- Drive the vehicle out of the lift if the lift is in the lowest position.

### 5.3 Equalisation of the Lift

- Press the button „Equalization the platform“ at the operation unit. The Platform of the lift equalize.

### 5.4 Function Microprocessor / Display-advertisement

- The automotive lift is equipped with a microprocessor. This system recognizes an unequal of the lift and regulate the hydraulic valves until the lift has the same height.
- The processor recognizes the present position of the cylinder. The lift switched off if the automotive lift reaches the top end position or the bottom end position or the position of the CE-Stop.
- The display shows the present position of the cylinder.
- this display is required also for the service-business, over a foil-keyboard.

### 5.5 The lift is not in the rule-window

- The lift switched off, if the lift is not in the rule-window of  $\pm 50$  mm.
- Read the chapter 5.6 step B to put the lift in the normal Function.

### 5.6 Function of the bypass-switch in case of unequal level of the platform



*Pic 2: Position of the bypass switch*

- A) Do not press the button „lifting“ shortly consecutively before the lift was lowered 50 mm. Otherwise the lift will raising over the top limit position. After, it is not possible to lower the lift again with the button „lowering“.

- B) In this case it is possible to lower the lift with the button „lowering and the bypass switch. Press both buttons simultaneously (see pic 2, arrow) until the lift has the normal function again.  
Take careful, otherwise a malfunction can occur.

## 6. Troubleshooting

If the lift does not work properly, the reason for this might be quite simple. Please check the lift for the potential reasons mentioned on the following pages. If the cause of trouble cannot be found, please call the technical service

### **Problem: Motor does not start!**

Potential causes:

- *no power supply*
- *main switch is not engaged*
- *fuse defective*
- *the feed line is cut*
- *Button „lifting“ defective*
- *Thermo fuse active*
- *Out of the rule-window  $\pm 50$  mm*

solution:

- Check the power supply*
- Check the main switch*
- Check the fuse*
- Check the feed line*
- Check the button*
- Let it cool down*
- Read chapter 5.5*

### **Problem: Motor starts, lift does not lifting!**

Potential causes:

- *The vehicle is too heavy*
- *Level of the oil is too low*
- *The hydraulic valve is defective*

solution:

- Unload the vehicle*
- Fill in new hydraulic oil*
- Call the lift service*

### **Problem: The lift does not lowered!**

Potential causes:

- *The lift is standing on a obstacle*
- *The hydraulic valve is defective*
- *fuse defective*
- *button „lowering“ is not pressed or defective*
- *the holding valve is defective*
- *the safety device is locked*

solution:

- Read chapter 6.1*
- Call the lift service*
- Check the fuse*
- Check the button*
- Call the lift service*
- Call the lift service*

### 6.1 Driving on an obstacle

If the Safety-Star-System recognizes a difference of  $\pm 50$  mm between the platforms then it switches off the lift.

## 6.1.1 Remove an obstacle



***Only trained and authorized staff is allowed to work with the DIP-switches! The main-switch has to be switched off!***

- Remove the cover of the operating unit and the control box.
- Press the button “lifting” and the bypass switch simultaneously. (pic 3, arrow).  
Raise the lift until the object can be removed.  
After it, lower the lift in the lowest position and enforce a reset.  
Take careful, otherwise a malfunction can occur.

## 6.2 Emergency lowering



***A emergency lowering is an intervention into the control of the lift and can be done only by experienced expert.***

***The emergency lowering must be carried in this order. Otherwise a malfunction can lead it to damages or lead to danger for body and lives.***



***Every kind of external leakage has to be removed. This is necessary in particular before an emergency lowering.***

***The emergency lowering may only be done by persons which are trained in using the lift.***

Reasons, that can make an emergency lowering necessary, are a defect of the electric system or disturbances of the valves, etc.

In case of power-failure or defective Valves there is the possibility through suitable tools to lower the lift in the lowest position, so that the vehicle can be driven off.

### 6.2.1 Procedure of the emergency lowering

- Switch off the main switch and safe it. (lock it)
- Remove the covers of hydraulic unit.
- Secure the dangerous place around the lift.



*Pic 6:*

***Loosen and remove the 2 lock nuts with a suitable tool in arrow direction. Carry out this process at both columns. (Key 41)***

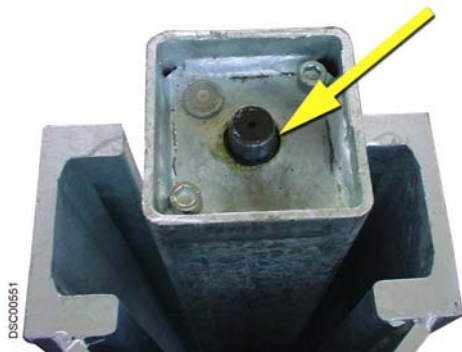

*Pic 7:*

*The piston rod can be stuck through the dirty deposit at the top of the hole. Use the solvent and lubricating stuff (for an example WD40) to loosen the connection. The WD40 is sprayed generously between the screw thread and the bore hole (see arrow). The time of the effect follows the contamination-degree.*

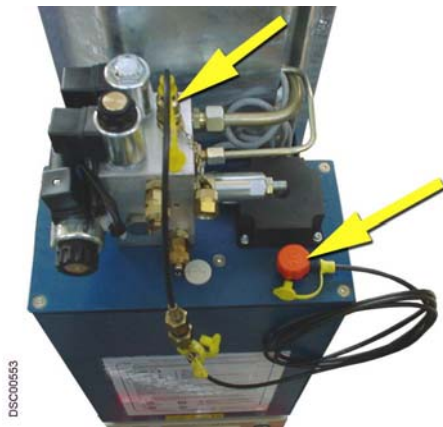

*Pic 8:*

*Loosen the cap of the Minimes connection and the cap of the tank. Fasten the Minimes hydraulic tube at the screw fitting and put the other end into the tank.*



*Pic 9:*

*Use the long screw thread-bushing and turns with a suitable tool (key-wideness 24, available with your dealer,), clockwise. Lower the lifting carriage only approx. 5cm – 10 cm. Repeat the process at the next column. Lower always 5 cm-10 cm until all lift are in the lowest position. Repair the defective lift. After it create a Reset which is described in the operating instruction.*



**Attention!!** Lower the automotive-lift only approx. 5cm – 10 cm.



**Observe the complete emergency lowering process.**



**Do not work with the lift until the defective parts are changed.**



*You can only work again with the automotive-lift, if it is in a safety-related perfect condition.*

- After it, carry out an reset as described in the operating instruction.

## 6.3 Reset the lift after an emergency lowering



*A reset of the system can be enforced, if the Mobile column lift are in the lowest position.*



*An access on the DIP-Switch can take place only with a switched off main switch and only through instructed, authorized technical personnel.*

- There must not be a vehicle on the lift.
- Remove the cover of the operating unit.
- Remove the cover of the electrical box.
- Press the button 1 (see pic. 5) and hold it.
- Switch-off the main switch and wait 5 sec. Hold the reset button.
- Switch-on the main switch and wait 5 sec. Hold the reset button.
- Let go off the reset button.
- Press the button „ lowering“ until both platforms are in the lowest position.
- If necessary repeat several times the steps d) until h) so that the lift is surely in the lowest position.
- After that move the Dip-switch 7 on position „on“.
- Dip-switch 5 stays on position „on“.
- Repeat the steps d) until h)
- After that, move the Dip-switch 7 on position „off“. Dip-switch 5 stays on position „on“.
- On the computer-board must now three diodes lighten permanently. One additional diode must be blinking in the frequency of approx. 1 sec.
- Raise and lower the automotive lift a few times without load. Observe the process.
- Mount the covers.

pic 5: controller

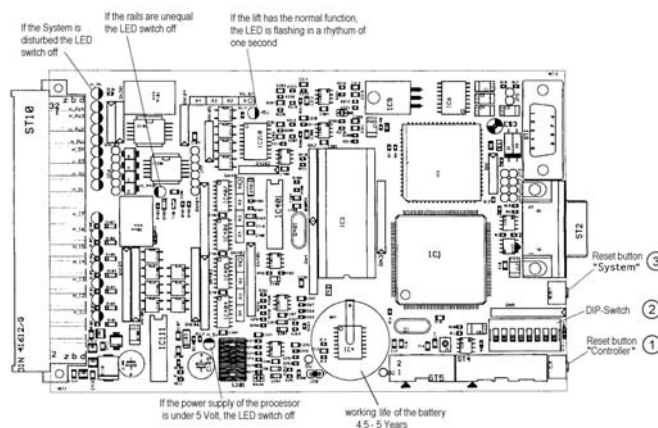



## 7. Inspection and Maintenance of Nussbaum lifts

 *Before a maintenance, all preparations are to enforce that with maintenance-working and repair-working at the lift no danger for body and lives and for damages of objects exists.*

A regular service has to be performed in regular distances of 3 months through the operator in accordance with following service manual. If the lift is in continuous operation or dirty environment, the maintenance rate has to be increased.

During daily operation the lift has to be watched carefully for its correct function. In case of any malfunction or leakage the technical service has to be informed.

### 7.1 Maintenance plan of the Mobile column lift

- In case of heavy dirt deposit clean the piston rods of the hydraulic cylinders from deposit. Remove the cover of the Mobile column lift. If necessary raise the Mobile column lift with the single-mode in the highest position.  
Grease the piston rods with a high capacity lipid (approx. 5 g of S2 DIN51503 KE2G of the Renolit Company).
- Clean and check the moving parts. Lubricate the moving parts of the lift (hinge bolts, rolls, sliding surfaces) grease with a multipurpose lipid (example: Auto Top 2000 LTD. Agip).
- Check the colour if necessary make a repair.
- Check the hydraulic tubes for leakage.
- Check the oil level. Fill in a clean, high quality oil (32 cst) in the tank.
- The hydraulic oil has to be changed at least once a year. To change the oil, lower the lift into the lowest position. Empty the tank and replaced clean oil, approx. 21 litres are needed. A high quality hydraulic oil is recommended, its should be 32 cst. (e.g.g. HLP 32 LTD. OEST Company)  
Use a ATF-Suffix hydraulic-oil (OEST Company ) if the ambient temperature is under 5 degree centigrade. After the fill up, the hydraulic oil must be between the upper and low marking of the oil level gauge.
- Check the welding of the lift.
- Check the safety device of the lift.
- Check the Battery of the controller (ASC). The Battery has a working life between 4 ½ - 5 Years. To avoid a permanent data-loss through an empty battery, the ASC must be sent for after 4 years into the Nussbaum headquarter. Please contact your service partner.
- Check the function of the hand lever.
- Check the turning moment of the screws (see the list pic. 6)

Turning moment for screws  
property class 8.8

	0,10*	0,15**	0,20***
M8	20	25	30
M10	40	50	60
M12	69	87	105
M16	170	220	260
M20	340	430	520
M24	590	740	890

property class 10.9

	0,10*	0,15**	0,20***
M8	30	37	44
M10	59	73	87
M12	100	125	151
M16	250	315	380
M20	490	615	740
M24	840	1050	1250

Drehmomenttabelle 8.8-10.9 E

\* sliding friction 0,10 for very good surfaces, lubricated  
 \*\* sliding friction 0,15 for good surfaces, lubricated oder dry  
 \*\*\* sliding friction 0,20 surface black or phosphatized, dry

pic 6:

## 7.2 Cleaning of the Mobile column lift

A regular and appropriate maintenance served the preservation of the lift. It can be a prerequisite for claims at possible corrosion. The best protection for the lift is the regular cleaning of dirt of all manner.

- Including this:

- de-icing salt
- sand, pebble stone, natural soil
- industrial dust of all manner
- water ; also in connection with other environmental influences
- aggressive deposit of all manner
- constant humidity by insufficient ventilation

### How often must the lift be cleaned ?

This is dependent on the use, of the working with the lift, of the cleanness of the workshop and location of the lift. The degree of the dirt is dependent on the season, of the weather conditions and the ventilation of the workshop.

Under bad circumstances it is necessary to clean the lift every week, but a cleaning every month can suffice.

Clean the lift and the floor with a non-aggressive and non-abrasive detergent. Use gentle detergent to clean the parts. Use an standard washing-up liquid and lukewarm water.

- Do not use for cleaning a steam jet cleaning
- Remove all dirt careful with a sponge if necessary with a brush.
- Pay attention that are no remains of the washing-up liquids on the lift after cleaning.
- Do not use aggressive means for cleaning the workshop floor and the automotive lift.
- A permanent contact with every kind of liquid is forbidden. Do not use any high pressure device for cleaning the lift.

## 8. Security check

The security check is necessary to guarantee the safety of the lifting during use. It has to be performed in the following cases:

1. Before the initial operation, after the first installation  
**Use the form “First security check before initiation”**
2. In regular intervals after the initial operation, at least annually.  
**Use the form “Regular security check at least annually”**
3. Every time the construction of that particular lift has been changed.  
**Use the form “Extraordinary security check”**

 *The first and the regular security check must be performed by a competent person. It is recommended to service the lift at this occasion.*

 *After the construction of the lift has been changed (changing the lifting height or capacity for example) and after serious maintenance works (welding on carrying parts) an extraordinary security check must be performed by an expert.*

This manual contains form with a schedule for the security checks. Please use the adequate form for the security checks. The form should remain in this manual after they have been filled out. In the following there is a short description about special safety devices.

## 9. Handing over and Initiation

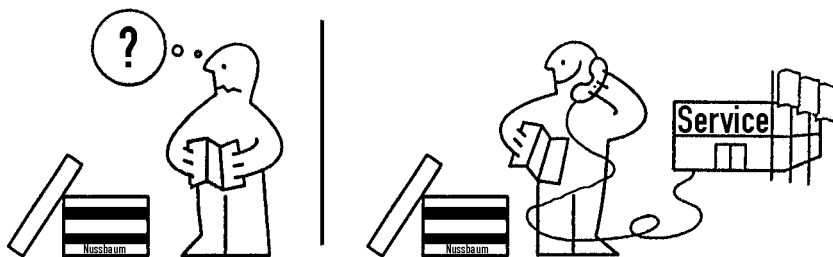

pic 7:

### 9.1 Regulations

- The installation of the lift is performed by trained technicians of the manufacturer or its distribution partner. If the operator can provide trained mechanics, he can install the lift by himself. The installation has to be done according to this regulation.
- The standard lift must not be installed in hazardous locations or washing areas.
- Before installation a sufficient foundation must be proved or constructed.  
An even installation place has to be provided. The foundations must be based in a frost resistance depth, both outside and indoors, where you must reckon with frost.



- An electrical supply 3~/N+PE, 400 V, 50 Hz has to be provided. The supply line must be protected with T16A (VDE0100 German regulation). The minimum diameter amounts to 2,5 mm<sup>2</sup>.
- All cable ducts have to be equipped with protective coverings to prevent accidents.

## 9.2 Erection and doweling of the lift

It is necessary to dowel the columns at 4 points and to safe the lift against slipping. For this a concrete floor without reinforcement, thickness of 1000 mm and quality B 25 is needed. In case of doubt a test drill is necessary and a dowel is to put in. Afterwards the dowel is to fasten with a specified torque (example: Liebig 50 Nm). If the necessary torque is too low or if there are cracks in the concrete floor, a foundation in accordance with the sheet "foundation plan" is to be erected. As well it has to be paid attention that the installation place is able to guarantee a horizontal erection of the lift.

- Put the runways on two erection trestles at installation place, pay attention of exactly difference between the runways (refer to data sheet).



pic. 8

Before mounting the crossbeam, remove the safety metal sheet.

After mounting the crossbeam, secure it with the metal-sheet again.

- Position the crossbeams on the face of the runways.
- Fasten the crossbeams on the runways.
- Introduce the connector into the platform and plug it. Observe the number and the position of the columns.
- Line up operating column (with bubble level) and drill holes for dowel-fixing through four bore-holes of base plates. Clean bore-holes with pressure air. Put in the safety dowels with washers in bore hole.
- Check the position of the lift and the position of the operating column again.
- The manufacturer demands LIEBIG safety dowels type B 15 (german dowel manufacturer) or equal dowels of another manufacturer (with allowance) but observe their regulations! Before doweling check concrete floor with quality B 25 if the concrete floor goes to the top edge of the floor. In this case the dowels have to be

chosen according to picture 9. If the ground is covered with floor tiles, the dowels have to be chosen according to picture 10.

- Check the position of the columns again. If there is an uneven floor even it with metal sheets. A continuous contact between the floor and the base plate must be guaranteed to avoid hollow spaces.
- Tighten the dowels with the dynamometric key (example Liebig-dowels  $M = 50Nm$ , (read the documentation of the dowel manufacturer)
- Fill in the hydraulic-oil approx. 20 litre per column.
- Connect the power supply.
- Press the button „lifting“.
- Check the hydraulic tubes of tightness.
- Remove the erection trestles.
- Lower the lift in the lowest position.
- If necessary create an reset (see chapter 6.3)
- Press the button „lifting“.
- Adjust the sliding guidance at the crossbeam (approx. 4-5 mm movement between the sliding guidance and the column).
- Mount the cover
- Raise and lower the lift several times with load. Check the torque of the dowels and check the hydraulic parts for tightness.

### 9.3 Adjusting the rail

The standard measure between the rails is 1000 mm. It is possible to adjust the rails +/-200 mm (see the datasheet).

- Lower the lift in the lowest position.
- Drive the vehicle from the lift.
- Loose the screws at the runways and adjust it.
- Tighten the screw.
- The lift has the normal function.

### 9.4 Changing the installation place

If the place of installation shall be changed, the new place has to be prepared in according to the regulations of the first installation. The changing should be performed in accordance with the following points:

- Lower the lift in the lowest position.
- Drive the vehicle from the lift.
- Remove the cover of the operating unit.
- Press the button „lifting“ to raise the lift on a working height
- Lower the lift on the erection trestles..

- Disconnect the power supply and the plugs under the platforms.
- Refill the oil.
- Loose the dowels.
- Loose the crossbeam and remove it.
- Transport the lift to the new installation place.
- Install lift in accordance with chapter "Installation and Initiation" of the lift.



*Use new dowels, the used dowels can not be used anymore.*



*A security check must be performed before preoperational by a competent person. Use form "Regular security check".*

## 9.5 Initiation



*Before the initiation a security check must be performed. Therefore use form: First security check.*

If the lift is installed by a competent person, he will perform this security check. If the operator installs the lift by himself, he has to instruct a competent person to perform the security check.

The competent confirms the faultless function of the lift in the installation record and form for the security check and allows the lift to be used.



*Please send the filled installation record to the manufacturer after the installation.*

pic. 9 choice of the dowel length without floor pavement or tile surface

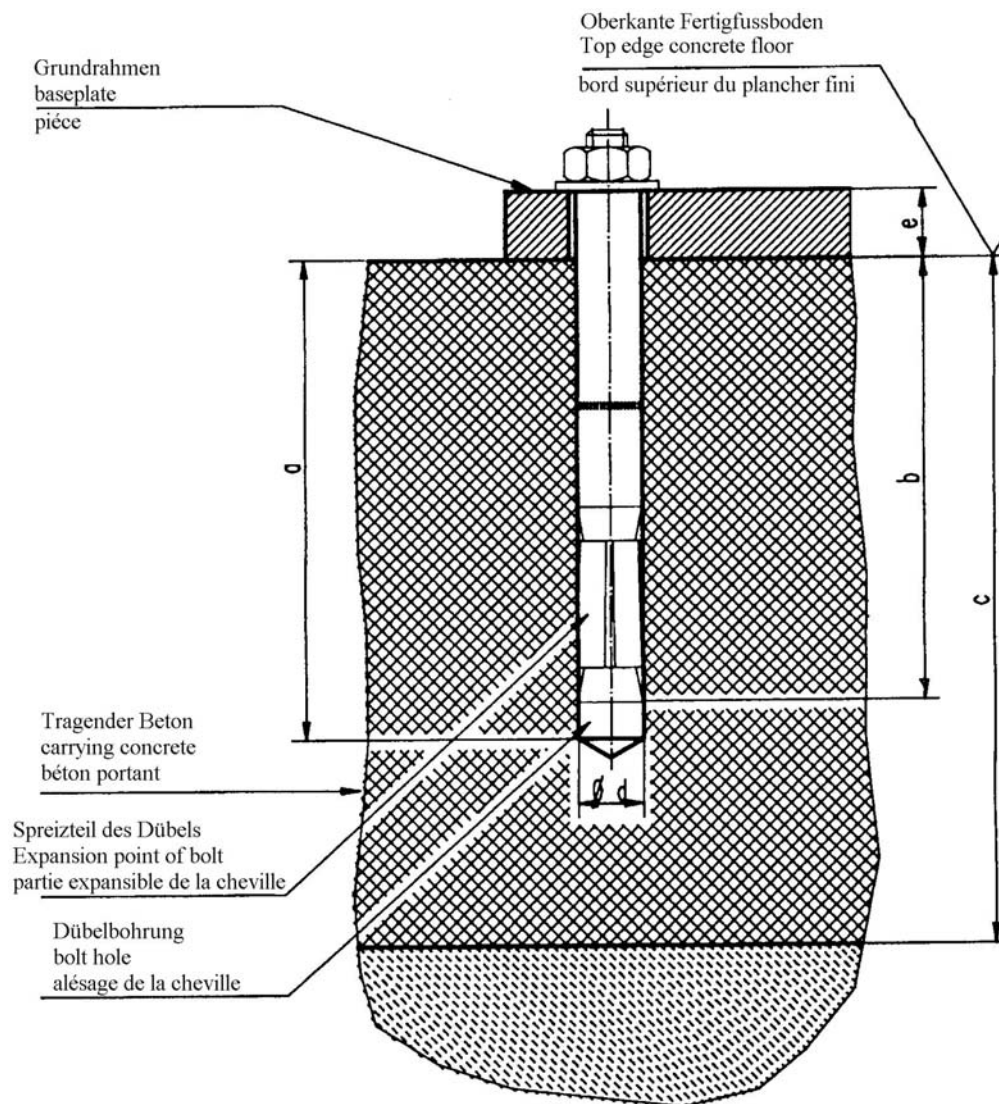

Table to pic. 9

Liebig-dowels

Dowel type		B15/75	B15/95
Drilling depth	a	112	112
Min. anchorage depth	b	72	72
Thickness of concrete	c	160	160
Diameter of bore	d	15	15
Thickness of the lift-pieces	e	0-40	40-65
Number of dowels		16	16
Starting torque		according to dowel manufacturer	



*You can use equivalent dowels from another dowel manufacturer (with license) but observe them.*



pic 10: choice of the dowel length with floor pavement or tile surface

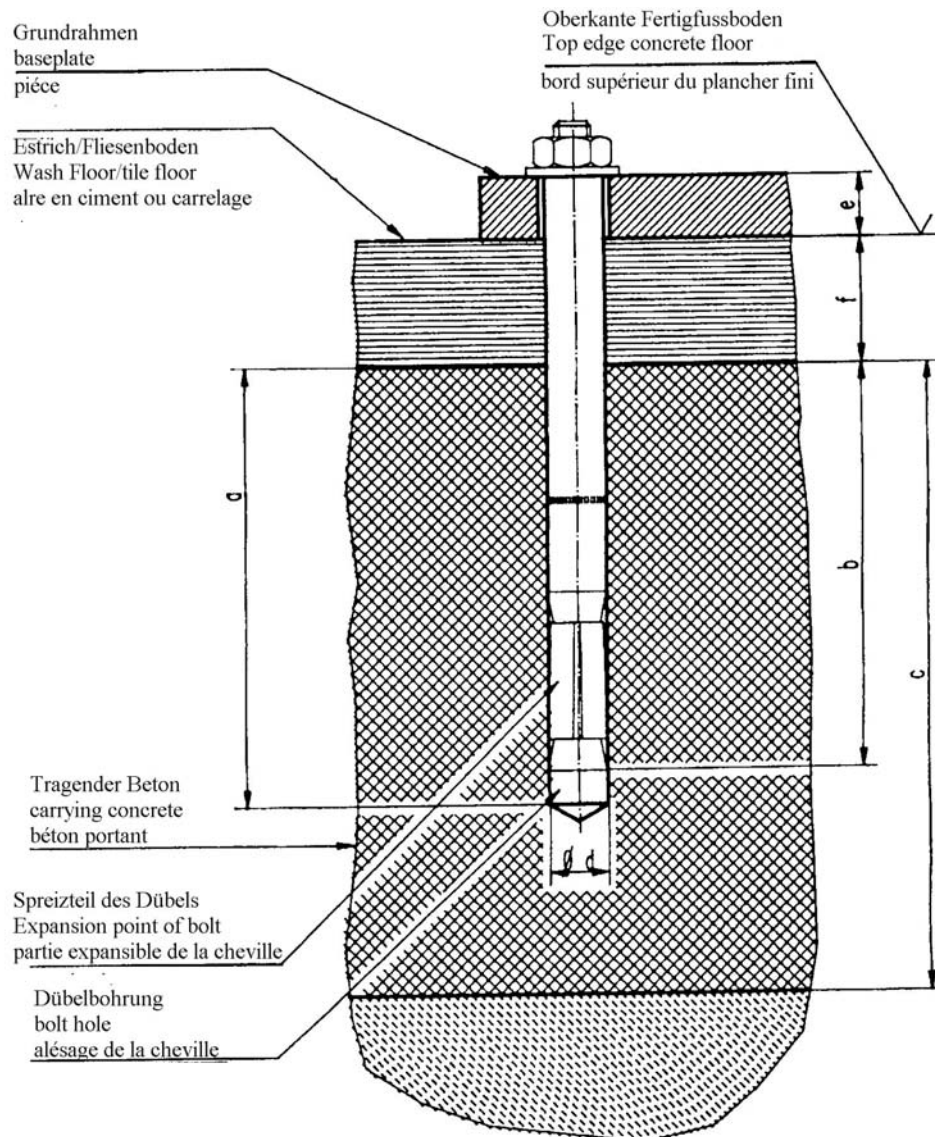

Table to pic. 10

Liebig-dowels

Dowel type		B15/70	B15/95	B15/120	B15/145
Drilling depth	a	112	137	162	187
Min. anchorage depth	b	72	72	72	72
Thickness of concrete	c	160	160	160	160
Diameter of bore	d	15	15	15	15
Thickness of the lift-pieces	e	0-40	40-65	65-90	90-115
Number of dowels		16	16	16	16
Starting torque		according to dowel manufacturer			



*You can use equivalent dowels from another dowel manufacturer (with license) but observe them.*

## First security check before installation

 Filling out and leave in this manual

kind of check	all right	defect missing	verification	remark
Type plate.....	<input type="checkbox"/>	<input type="checkbox"/>	<input type="checkbox"/>	.....
Short operating instruction.....	<input type="checkbox"/>	<input type="checkbox"/>	<input type="checkbox"/>	.....
Warning designation.....	<input type="checkbox"/>	<input type="checkbox"/>	<input type="checkbox"/>	.....
Sticker "max. capacity".....	<input type="checkbox"/>	<input type="checkbox"/>	<input type="checkbox"/>	.....
Designation lifting/lowering.....	<input type="checkbox"/>	<input type="checkbox"/>	<input type="checkbox"/>	.....
Detailed operating instruction.....	<input type="checkbox"/>	<input type="checkbox"/>	<input type="checkbox"/>	.....
Condition concrete.....	<input type="checkbox"/>	<input type="checkbox"/>	<input type="checkbox"/>	.....
Safety device of hinge bolt.....	<input type="checkbox"/>	<input type="checkbox"/>	<input type="checkbox"/>	.....
Condition/Function Ramps.....	<input type="checkbox"/>	<input type="checkbox"/>	<input type="checkbox"/>	.....
Condition automotive lift.....	<input type="checkbox"/>	<input type="checkbox"/>	<input type="checkbox"/>	.....
Condition colour.....	<input type="checkbox"/>	<input type="checkbox"/>	<input type="checkbox"/>	.....
Construction (deformation, cracking) .....	<input type="checkbox"/>	<input type="checkbox"/>	<input type="checkbox"/>	.....
Torque of the dowels .....	<input type="checkbox"/>	<input type="checkbox"/>	<input type="checkbox"/>	.....
torque moments of the screws and dowels.....	<input type="checkbox"/>	<input type="checkbox"/>	<input type="checkbox"/>	.....
Condition operating unit.....	<input type="checkbox"/>	<input type="checkbox"/>	<input type="checkbox"/>	.....
Condition surface piston rod .....	<input type="checkbox"/>	<input type="checkbox"/>	<input type="checkbox"/>	.....
Condition coverings.....	<input type="checkbox"/>	<input type="checkbox"/>	<input type="checkbox"/>	.....
Condition electrical wires .....	<input type="checkbox"/>	<input type="checkbox"/>	<input type="checkbox"/>	.....
Level of hydraulic oil .....	<input type="checkbox"/>	<input type="checkbox"/>	<input type="checkbox"/>	.....
Closeness of the hydraulic system.....	<input type="checkbox"/>	<input type="checkbox"/>	<input type="checkbox"/>	.....
Condition hydraulic hoses.....	<input type="checkbox"/>	<input type="checkbox"/>	<input type="checkbox"/>	.....
Function test with vehicle.....	<input type="checkbox"/>	<input type="checkbox"/>	<input type="checkbox"/>	.....
Function safety devices.....	<input type="checkbox"/>	<input type="checkbox"/>	<input type="checkbox"/>	.....
Condition welding.....	<input type="checkbox"/>	<input type="checkbox"/>	<input type="checkbox"/>	.....
Function/condition slide-guidance.....	<input type="checkbox"/>	<input type="checkbox"/>	<input type="checkbox"/>	.....
Condition runways.....	<input type="checkbox"/>	<input type="checkbox"/>	<input type="checkbox"/>	.....
Condition columns.....	<input type="checkbox"/>	<input type="checkbox"/>	<input type="checkbox"/>	.....
Function CE-Stop.....	<input type="checkbox"/>	<input type="checkbox"/>	<input type="checkbox"/>	.....

**( mark here applicable, in case of verification mark in addition to the first mark!)**

Security check carried out:.....

Carried out the company:.....

Name, address of the competent:.....

Result of the Check:

- Initiation not permitted, verification necessary
- Initiation possible, repair failures until.....
- No failings, Initiation possible

.....  
signature of the expert

.....  
signature of the operator

If failures must be repaired:

Failures repaired at: .....signature of the operator  
(Use another form for verification!)

## Regular security check

 Filling out and leave in this manual

kind of check	all right	defect missing	verification	remark
Type plate.....	<input type="checkbox"/>	<input type="checkbox"/>	<input type="checkbox"/>	.....
Short operating instruction.....	<input type="checkbox"/>	<input type="checkbox"/>	<input type="checkbox"/>	.....
Warning designation.....	<input type="checkbox"/>	<input type="checkbox"/>	<input type="checkbox"/>	.....
Sticker "max. capacity".....	<input type="checkbox"/>	<input type="checkbox"/>	<input type="checkbox"/>	.....
Designation lifting/lowering.....	<input type="checkbox"/>	<input type="checkbox"/>	<input type="checkbox"/>	.....
Detailed operating instruction.....	<input type="checkbox"/>	<input type="checkbox"/>	<input type="checkbox"/>	.....
Condition concrete.....	<input type="checkbox"/>	<input type="checkbox"/>	<input type="checkbox"/>	.....
Safety device of hinge bolt.....	<input type="checkbox"/>	<input type="checkbox"/>	<input type="checkbox"/>	.....
Condition/Function Ramps.....	<input type="checkbox"/>	<input type="checkbox"/>	<input type="checkbox"/>	.....
Condition automotive lift.....	<input type="checkbox"/>	<input type="checkbox"/>	<input type="checkbox"/>	.....
Condition colour.....	<input type="checkbox"/>	<input type="checkbox"/>	<input type="checkbox"/>	.....
Construction (deformation, cracking) .....	<input type="checkbox"/>	<input type="checkbox"/>	<input type="checkbox"/>	.....
Torque of the dowels .....	<input type="checkbox"/>	<input type="checkbox"/>	<input type="checkbox"/>	.....
torque moments of the screws and dowels.....	<input type="checkbox"/>	<input type="checkbox"/>	<input type="checkbox"/>	.....
Condition operating unit.....	<input type="checkbox"/>	<input type="checkbox"/>	<input type="checkbox"/>	.....
Condition surface piston rod .....	<input type="checkbox"/>	<input type="checkbox"/>	<input type="checkbox"/>	.....
Condition coverings.....	<input type="checkbox"/>	<input type="checkbox"/>	<input type="checkbox"/>	.....
Condition electrical wires .....	<input type="checkbox"/>	<input type="checkbox"/>	<input type="checkbox"/>	.....
Level of hydraulic oil .....	<input type="checkbox"/>	<input type="checkbox"/>	<input type="checkbox"/>	.....
Closeness of the hydraulic system.....	<input type="checkbox"/>	<input type="checkbox"/>	<input type="checkbox"/>	.....
Condition hydraulic hoses.....	<input type="checkbox"/>	<input type="checkbox"/>	<input type="checkbox"/>	.....
Function test with vehicle.....	<input type="checkbox"/>	<input type="checkbox"/>	<input type="checkbox"/>	.....
Function safety devices.....	<input type="checkbox"/>	<input type="checkbox"/>	<input type="checkbox"/>	.....
Condition welding.....	<input type="checkbox"/>	<input type="checkbox"/>	<input type="checkbox"/>	.....
Function/condition slide-guidance.....	<input type="checkbox"/>	<input type="checkbox"/>	<input type="checkbox"/>	.....
Condition runways.....	<input type="checkbox"/>	<input type="checkbox"/>	<input type="checkbox"/>	.....
Condition columns.....	<input type="checkbox"/>	<input type="checkbox"/>	<input type="checkbox"/>	.....
Function CE-Stop.....	<input type="checkbox"/>	<input type="checkbox"/>	<input type="checkbox"/>	.....

( mark here applicable, in case of verification mark in addition to the first mark!)

Security check carried out:.....

Carried out the company:.....

Name, address of the competent:.....

Result of the Check:

- Initiation not permitted, verification necessary
- Initiation possible, repair failures until.....
- No failings, Initiation possible

.....  
signature of the expert

.....  
signature of the operator

If failures must be repaired:

Failures repaired at: .....signature of the operator  
(Use another form for verification!)

## Regular security check

 Filling out and leave in this manual

kind of check	all right	defect missing	ver-ification	remark
Type plate.....	<input type="checkbox"/>	<input type="checkbox"/>	<input type="checkbox"/>	.....
Short operating instruction.....	<input type="checkbox"/>	<input type="checkbox"/>	<input type="checkbox"/>	.....
Warning designation.....	<input type="checkbox"/>	<input type="checkbox"/>	<input type="checkbox"/>	.....
Sticker "max. capacity".....	<input type="checkbox"/>	<input type="checkbox"/>	<input type="checkbox"/>	.....
Designation lifting/lowering.....	<input type="checkbox"/>	<input type="checkbox"/>	<input type="checkbox"/>	.....
Detailed operating instruction.....	<input type="checkbox"/>	<input type="checkbox"/>	<input type="checkbox"/>	.....
Condition concrete.....	<input type="checkbox"/>	<input type="checkbox"/>	<input type="checkbox"/>	.....
Safety device of hinge bolt.....	<input type="checkbox"/>	<input type="checkbox"/>	<input type="checkbox"/>	.....
Condition/Function Ramps.....	<input type="checkbox"/>	<input type="checkbox"/>	<input type="checkbox"/>	.....
Condition automotive lift.....	<input type="checkbox"/>	<input type="checkbox"/>	<input type="checkbox"/>	.....
Condition colour.....	<input type="checkbox"/>	<input type="checkbox"/>	<input type="checkbox"/>	.....
Construction (deformation, cracking) .....	<input type="checkbox"/>	<input type="checkbox"/>	<input type="checkbox"/>	.....
Torque of the dowels .....	<input type="checkbox"/>	<input type="checkbox"/>	<input type="checkbox"/>	.....
torque moments of the screws and dowels.....	<input type="checkbox"/>	<input type="checkbox"/>	<input type="checkbox"/>	.....
Condition operating unit.....	<input type="checkbox"/>	<input type="checkbox"/>	<input type="checkbox"/>	.....
Condition surface piston rod .....	<input type="checkbox"/>	<input type="checkbox"/>	<input type="checkbox"/>	.....
Condition coverings.....	<input type="checkbox"/>	<input type="checkbox"/>	<input type="checkbox"/>	.....
Condition electrical wires .....	<input type="checkbox"/>	<input type="checkbox"/>	<input type="checkbox"/>	.....
Level of hydraulic oil .....	<input type="checkbox"/>	<input type="checkbox"/>	<input type="checkbox"/>	.....
Closeness of the hydraulic system.....	<input type="checkbox"/>	<input type="checkbox"/>	<input type="checkbox"/>	.....
Condition hydraulic hoses.....	<input type="checkbox"/>	<input type="checkbox"/>	<input type="checkbox"/>	.....
Function test with vehicle.....	<input type="checkbox"/>	<input type="checkbox"/>	<input type="checkbox"/>	.....
Function safety devices.....	<input type="checkbox"/>	<input type="checkbox"/>	<input type="checkbox"/>	.....
Condition welding.....	<input type="checkbox"/>	<input type="checkbox"/>	<input type="checkbox"/>	.....
Function/condition slide-guidance.....	<input type="checkbox"/>	<input type="checkbox"/>	<input type="checkbox"/>	.....
Condition runways.....	<input type="checkbox"/>	<input type="checkbox"/>	<input type="checkbox"/>	.....
Condition columns.....	<input type="checkbox"/>	<input type="checkbox"/>	<input type="checkbox"/>	.....
Function CE-Stop.....	<input type="checkbox"/>	<input type="checkbox"/>	<input type="checkbox"/>	.....

( mark here applicable, in case of verification mark in addition to the first mark!)

Security check carried out:.....

Carried out the company:.....

Name, address of the competent:.....

Result of the Check:

- Initiation not permitted, verification necessary
- Initiation possible, repair failures until.....
- No failings, Initiation possible

.....  
signature of the expert

.....  
signature of the operator

If failures must be repaired:

Failures repaired at: .....signature of the operator  
(Use another form for verification!)



## Regular security check

 Filling out and leave in this manual

kind of check	all right	defect missing	veri- fication	remark
Type plate.....	<input type="checkbox"/>	<input type="checkbox"/>	<input type="checkbox"/>	.....
Short operating instruction.....	<input type="checkbox"/>	<input type="checkbox"/>	<input type="checkbox"/>	.....
Warning designation.....	<input type="checkbox"/>	<input type="checkbox"/>	<input type="checkbox"/>	.....
Sticker "max. capacity".....	<input type="checkbox"/>	<input type="checkbox"/>	<input type="checkbox"/>	.....
Designation lifting/lowering.....	<input type="checkbox"/>	<input type="checkbox"/>	<input type="checkbox"/>	.....
Detailed operating instruction.....	<input type="checkbox"/>	<input type="checkbox"/>	<input type="checkbox"/>	.....
Condition concrete.....	<input type="checkbox"/>	<input type="checkbox"/>	<input type="checkbox"/>	.....
Safety device of hinge bolt.....	<input type="checkbox"/>	<input type="checkbox"/>	<input type="checkbox"/>	.....
Condition/Function Ramps.....	<input type="checkbox"/>	<input type="checkbox"/>	<input type="checkbox"/>	.....
Condition automotive lift.....	<input type="checkbox"/>	<input type="checkbox"/>	<input type="checkbox"/>	.....
Condition colour.....	<input type="checkbox"/>	<input type="checkbox"/>	<input type="checkbox"/>	.....
Construction (deformation, cracking) .....	<input type="checkbox"/>	<input type="checkbox"/>	<input type="checkbox"/>	.....
Torque of the dowels .....	<input type="checkbox"/>	<input type="checkbox"/>	<input type="checkbox"/>	.....
torque moments of the screws and dowels.....	<input type="checkbox"/>	<input type="checkbox"/>	<input type="checkbox"/>	.....
Condition operating unit.....	<input type="checkbox"/>	<input type="checkbox"/>	<input type="checkbox"/>	.....
Condition surface piston rod .....	<input type="checkbox"/>	<input type="checkbox"/>	<input type="checkbox"/>	.....
Condition coverings.....	<input type="checkbox"/>	<input type="checkbox"/>	<input type="checkbox"/>	.....
Condition electrical wires .....	<input type="checkbox"/>	<input type="checkbox"/>	<input type="checkbox"/>	.....
Level of hydraulic oil .....	<input type="checkbox"/>	<input type="checkbox"/>	<input type="checkbox"/>	.....
Closeness of the hydraulic system.....	<input type="checkbox"/>	<input type="checkbox"/>	<input type="checkbox"/>	.....
Condition hydraulic hoses.....	<input type="checkbox"/>	<input type="checkbox"/>	<input type="checkbox"/>	.....
Function test with vehicle.....	<input type="checkbox"/>	<input type="checkbox"/>	<input type="checkbox"/>	.....
Function safety devices.....	<input type="checkbox"/>	<input type="checkbox"/>	<input type="checkbox"/>	.....
Condition welding.....	<input type="checkbox"/>	<input type="checkbox"/>	<input type="checkbox"/>	.....
Function/condition slide-guidance.....	<input type="checkbox"/>	<input type="checkbox"/>	<input type="checkbox"/>	.....
Condition runways.....	<input type="checkbox"/>	<input type="checkbox"/>	<input type="checkbox"/>	.....
Condition columns.....	<input type="checkbox"/>	<input type="checkbox"/>	<input type="checkbox"/>	.....
Function CE-Stop.....	<input type="checkbox"/>	<input type="checkbox"/>	<input type="checkbox"/>	.....

( mark here applicable, in case of verification mark in addition to the first mark!)

Security check carried out:.....

Carried out the company:.....

Name, address of the competent:.....

Result of the Check:

- Initiation not permitted, verification necessary
- Initiation possible, repair failures until.....
- No failings, Initiation possible

.....  
signature of the expert

.....  
signature of the operator

If failures must be repaired:

Failures repaired at: .....signature of the operator  
(Use another form for verification!)

## Regular security check

 Filling out and leave in this manual

kind of check	all right	defect missing	verification	remark
Type plate.....	<input type="checkbox"/>	<input type="checkbox"/>	<input type="checkbox"/>	.....
Short operating instruction.....	<input type="checkbox"/>	<input type="checkbox"/>	<input type="checkbox"/>	.....
Warning designation.....	<input type="checkbox"/>	<input type="checkbox"/>	<input type="checkbox"/>	.....
Sticker "max. capacity".....	<input type="checkbox"/>	<input type="checkbox"/>	<input type="checkbox"/>	.....
Designation lifting/lowering.....	<input type="checkbox"/>	<input type="checkbox"/>	<input type="checkbox"/>	.....
Detailed operating instruction.....	<input type="checkbox"/>	<input type="checkbox"/>	<input type="checkbox"/>	.....
Condition concrete.....	<input type="checkbox"/>	<input type="checkbox"/>	<input type="checkbox"/>	.....
Safety device of hinge bolt.....	<input type="checkbox"/>	<input type="checkbox"/>	<input type="checkbox"/>	.....
Condition/Function Ramps.....	<input type="checkbox"/>	<input type="checkbox"/>	<input type="checkbox"/>	.....
Condition automotive lift.....	<input type="checkbox"/>	<input type="checkbox"/>	<input type="checkbox"/>	.....
Condition colour.....	<input type="checkbox"/>	<input type="checkbox"/>	<input type="checkbox"/>	.....
Construction (deformation, cracking) .....	<input type="checkbox"/>	<input type="checkbox"/>	<input type="checkbox"/>	.....
Torque of the dowels .....	<input type="checkbox"/>	<input type="checkbox"/>	<input type="checkbox"/>	.....
torque moments of the screws and dowels.....	<input type="checkbox"/>	<input type="checkbox"/>	<input type="checkbox"/>	.....
Condition operating unit.....	<input type="checkbox"/>	<input type="checkbox"/>	<input type="checkbox"/>	.....
Condition surface piston rod .....	<input type="checkbox"/>	<input type="checkbox"/>	<input type="checkbox"/>	.....
Condition coverings.....	<input type="checkbox"/>	<input type="checkbox"/>	<input type="checkbox"/>	.....
Condition electrical wires .....	<input type="checkbox"/>	<input type="checkbox"/>	<input type="checkbox"/>	.....
Level of hydraulic oil .....	<input type="checkbox"/>	<input type="checkbox"/>	<input type="checkbox"/>	.....
Closeness of the hydraulic system.....	<input type="checkbox"/>	<input type="checkbox"/>	<input type="checkbox"/>	.....
Condition hydraulic hoses.....	<input type="checkbox"/>	<input type="checkbox"/>	<input type="checkbox"/>	.....
Function test with vehicle.....	<input type="checkbox"/>	<input type="checkbox"/>	<input type="checkbox"/>	.....
Function safety devices.....	<input type="checkbox"/>	<input type="checkbox"/>	<input type="checkbox"/>	.....
Condition welding.....	<input type="checkbox"/>	<input type="checkbox"/>	<input type="checkbox"/>	.....
Function/condition slide-guidance.....	<input type="checkbox"/>	<input type="checkbox"/>	<input type="checkbox"/>	.....
Condition runways.....	<input type="checkbox"/>	<input type="checkbox"/>	<input type="checkbox"/>	.....
Condition columns.....	<input type="checkbox"/>	<input type="checkbox"/>	<input type="checkbox"/>	.....
Function CE-Stop.....	<input type="checkbox"/>	<input type="checkbox"/>	<input type="checkbox"/>	.....

( mark here applicable, in case of verification mark in addition to the first mark!)

Security check carried out:.....

Carried out the company:.....

Name, address of the competent:.....

Result of the Check:

- Initiation not permitted, verification necessary
- Initiation possible, repair failures until.....
- No failings, Initiation possible

.....  
signature of the expert

.....  
signature of the operator

If failures must be repaired:

Failures repaired at: .....signature of the operator  
(Use another form for verification!)

## Regular security check

 Filling out and leave in this manual

kind of check	all right	defect missing	verification	remark
Type plate.....	<input type="checkbox"/>	<input type="checkbox"/>	<input type="checkbox"/>	.....
Short operating instruction.....	<input type="checkbox"/>	<input type="checkbox"/>	<input type="checkbox"/>	.....
Warning designation.....	<input type="checkbox"/>	<input type="checkbox"/>	<input type="checkbox"/>	.....
Sticker "max. capacity".....	<input type="checkbox"/>	<input type="checkbox"/>	<input type="checkbox"/>	.....
Designation lifting/lowering.....	<input type="checkbox"/>	<input type="checkbox"/>	<input type="checkbox"/>	.....
Detailed operating instruction.....	<input type="checkbox"/>	<input type="checkbox"/>	<input type="checkbox"/>	.....
Condition concrete.....	<input type="checkbox"/>	<input type="checkbox"/>	<input type="checkbox"/>	.....
Safety device of hinge bolt.....	<input type="checkbox"/>	<input type="checkbox"/>	<input type="checkbox"/>	.....
Condition/Function Ramps.....	<input type="checkbox"/>	<input type="checkbox"/>	<input type="checkbox"/>	.....
Condition automotive lift.....	<input type="checkbox"/>	<input type="checkbox"/>	<input type="checkbox"/>	.....
Condition colour.....	<input type="checkbox"/>	<input type="checkbox"/>	<input type="checkbox"/>	.....
Construction (deformation, cracking) .....	<input type="checkbox"/>	<input type="checkbox"/>	<input type="checkbox"/>	.....
Torque of the dowels .....	<input type="checkbox"/>	<input type="checkbox"/>	<input type="checkbox"/>	.....
torque moments of the screws and dowels.....	<input type="checkbox"/>	<input type="checkbox"/>	<input type="checkbox"/>	.....
Condition operating unit.....	<input type="checkbox"/>	<input type="checkbox"/>	<input type="checkbox"/>	.....
Condition surface piston rod .....	<input type="checkbox"/>	<input type="checkbox"/>	<input type="checkbox"/>	.....
Condition coverings.....	<input type="checkbox"/>	<input type="checkbox"/>	<input type="checkbox"/>	.....
Condition electrical wires .....	<input type="checkbox"/>	<input type="checkbox"/>	<input type="checkbox"/>	.....
Level of hydraulic oil .....	<input type="checkbox"/>	<input type="checkbox"/>	<input type="checkbox"/>	.....
Closeness of the hydraulic system.....	<input type="checkbox"/>	<input type="checkbox"/>	<input type="checkbox"/>	.....
Condition hydraulic hoses.....	<input type="checkbox"/>	<input type="checkbox"/>	<input type="checkbox"/>	.....
Function test with vehicle.....	<input type="checkbox"/>	<input type="checkbox"/>	<input type="checkbox"/>	.....
Function safety devices.....	<input type="checkbox"/>	<input type="checkbox"/>	<input type="checkbox"/>	.....
Condition welding.....	<input type="checkbox"/>	<input type="checkbox"/>	<input type="checkbox"/>	.....
Function/condition slide-guidance.....	<input type="checkbox"/>	<input type="checkbox"/>	<input type="checkbox"/>	.....
Condition runways.....	<input type="checkbox"/>	<input type="checkbox"/>	<input type="checkbox"/>	.....
Condition columns.....	<input type="checkbox"/>	<input type="checkbox"/>	<input type="checkbox"/>	.....
Function CE-Stop.....	<input type="checkbox"/>	<input type="checkbox"/>	<input type="checkbox"/>	.....

( mark here applicable, in case of verification mark in addition to the first mark!)

Security check carried out:.....

Carried out the company:.....

Name, address of the competent:.....

Result of the Check:

- Initiation not permitted, verification necessary
- Initiation possible, repair failures until.....
- No failings, Initiation possible

.....  
signature of the expert

.....  
signature of the operator

If failures must be repaired:

Failures repaired at: .....signature of the operator  
(Use another form for verification!)

## Regular security check

 Filling out and leave in this manual

kind of check	all right	defect missing	verification	remark
Type plate.....	<input type="checkbox"/>	<input type="checkbox"/>	<input type="checkbox"/>	.....
Short operating instruction.....	<input type="checkbox"/>	<input type="checkbox"/>	<input type="checkbox"/>	.....
Warning designation.....	<input type="checkbox"/>	<input type="checkbox"/>	<input type="checkbox"/>	.....
Sticker "max. capacity".....	<input type="checkbox"/>	<input type="checkbox"/>	<input type="checkbox"/>	.....
Designation lifting/lowering.....	<input type="checkbox"/>	<input type="checkbox"/>	<input type="checkbox"/>	.....
Detailed operating instruction.....	<input type="checkbox"/>	<input type="checkbox"/>	<input type="checkbox"/>	.....
Condition concrete.....	<input type="checkbox"/>	<input type="checkbox"/>	<input type="checkbox"/>	.....
Safety device of hinge bolt.....	<input type="checkbox"/>	<input type="checkbox"/>	<input type="checkbox"/>	.....
Condition/Function Ramps.....	<input type="checkbox"/>	<input type="checkbox"/>	<input type="checkbox"/>	.....
Condition automotive lift.....	<input type="checkbox"/>	<input type="checkbox"/>	<input type="checkbox"/>	.....
Condition colour.....	<input type="checkbox"/>	<input type="checkbox"/>	<input type="checkbox"/>	.....
Construction (deformation, cracking) .....	<input type="checkbox"/>	<input type="checkbox"/>	<input type="checkbox"/>	.....
Torque of the dowels .....	<input type="checkbox"/>	<input type="checkbox"/>	<input type="checkbox"/>	.....
torque moments of the screws and dowels.....	<input type="checkbox"/>	<input type="checkbox"/>	<input type="checkbox"/>	.....
Condition operating unit.....	<input type="checkbox"/>	<input type="checkbox"/>	<input type="checkbox"/>	.....
Condition surface piston rod .....	<input type="checkbox"/>	<input type="checkbox"/>	<input type="checkbox"/>	.....
Condition coverings.....	<input type="checkbox"/>	<input type="checkbox"/>	<input type="checkbox"/>	.....
Condition electrical wires .....	<input type="checkbox"/>	<input type="checkbox"/>	<input type="checkbox"/>	.....
Level of hydraulic oil .....	<input type="checkbox"/>	<input type="checkbox"/>	<input type="checkbox"/>	.....
Closeness of the hydraulic system.....	<input type="checkbox"/>	<input type="checkbox"/>	<input type="checkbox"/>	.....
Condition hydraulic hoses.....	<input type="checkbox"/>	<input type="checkbox"/>	<input type="checkbox"/>	.....
Function test with vehicle.....	<input type="checkbox"/>	<input type="checkbox"/>	<input type="checkbox"/>	.....
Function safety devices.....	<input type="checkbox"/>	<input type="checkbox"/>	<input type="checkbox"/>	.....
Condition welding.....	<input type="checkbox"/>	<input type="checkbox"/>	<input type="checkbox"/>	.....
Function/condition slide-guidance.....	<input type="checkbox"/>	<input type="checkbox"/>	<input type="checkbox"/>	.....
Condition runways.....	<input type="checkbox"/>	<input type="checkbox"/>	<input type="checkbox"/>	.....
Condition columns.....	<input type="checkbox"/>	<input type="checkbox"/>	<input type="checkbox"/>	.....
Function CE-Stop.....	<input type="checkbox"/>	<input type="checkbox"/>	<input type="checkbox"/>	.....

( mark here applicable, in case of verification mark in addition to the first mark!)

Security check carried out:.....

Carried out the company:.....

Name, address of the competent:.....

Result of the Check:

- Initiation not permitted, verification necessary
- Initiation possible, repair failures until.....
- No failings, Initiation possible

.....  
signature of the expert

.....  
signature of the operator

If failures must be repaired:

Failures repaired at: .....signature of the operator  
(Use another form for verification!)

## Regular security check

 Filling out and leave in this manual

kind of check	all right	defect missing	verification	remark
Type plate.....	<input type="checkbox"/>	<input type="checkbox"/>	<input type="checkbox"/>	.....
Short operating instruction.....	<input type="checkbox"/>	<input type="checkbox"/>	<input type="checkbox"/>	.....
Warning designation.....	<input type="checkbox"/>	<input type="checkbox"/>	<input type="checkbox"/>	.....
Sticker "max. capacity".....	<input type="checkbox"/>	<input type="checkbox"/>	<input type="checkbox"/>	.....
Designation lifting/lowering.....	<input type="checkbox"/>	<input type="checkbox"/>	<input type="checkbox"/>	.....
Detailed operating instruction.....	<input type="checkbox"/>	<input type="checkbox"/>	<input type="checkbox"/>	.....
Condition concrete.....	<input type="checkbox"/>	<input type="checkbox"/>	<input type="checkbox"/>	.....
Safety device of hinge bolt.....	<input type="checkbox"/>	<input type="checkbox"/>	<input type="checkbox"/>	.....
Condition/Function Ramps.....	<input type="checkbox"/>	<input type="checkbox"/>	<input type="checkbox"/>	.....
Condition automotive lift.....	<input type="checkbox"/>	<input type="checkbox"/>	<input type="checkbox"/>	.....
Condition colour.....	<input type="checkbox"/>	<input type="checkbox"/>	<input type="checkbox"/>	.....
Construction (deformation, cracking) .....	<input type="checkbox"/>	<input type="checkbox"/>	<input type="checkbox"/>	.....
Torque of the dowels .....	<input type="checkbox"/>	<input type="checkbox"/>	<input type="checkbox"/>	.....
torque moments of the screws and dowels.....	<input type="checkbox"/>	<input type="checkbox"/>	<input type="checkbox"/>	.....
Condition operating unit.....	<input type="checkbox"/>	<input type="checkbox"/>	<input type="checkbox"/>	.....
Condition surface piston rod .....	<input type="checkbox"/>	<input type="checkbox"/>	<input type="checkbox"/>	.....
Condition coverings.....	<input type="checkbox"/>	<input type="checkbox"/>	<input type="checkbox"/>	.....
Condition electrical wires .....	<input type="checkbox"/>	<input type="checkbox"/>	<input type="checkbox"/>	.....
Level of hydraulic oil .....	<input type="checkbox"/>	<input type="checkbox"/>	<input type="checkbox"/>	.....
Closeness of the hydraulic system.....	<input type="checkbox"/>	<input type="checkbox"/>	<input type="checkbox"/>	.....
Condition hydraulic hoses.....	<input type="checkbox"/>	<input type="checkbox"/>	<input type="checkbox"/>	.....
Function test with vehicle.....	<input type="checkbox"/>	<input type="checkbox"/>	<input type="checkbox"/>	.....
Function safety devices.....	<input type="checkbox"/>	<input type="checkbox"/>	<input type="checkbox"/>	.....
Condition welding.....	<input type="checkbox"/>	<input type="checkbox"/>	<input type="checkbox"/>	.....
Function/condition slide-guidance.....	<input type="checkbox"/>	<input type="checkbox"/>	<input type="checkbox"/>	.....
Condition runways.....	<input type="checkbox"/>	<input type="checkbox"/>	<input type="checkbox"/>	.....
Condition columns.....	<input type="checkbox"/>	<input type="checkbox"/>	<input type="checkbox"/>	.....
Function CE-Stop.....	<input type="checkbox"/>	<input type="checkbox"/>	<input type="checkbox"/>	.....

( mark here applicable, in case of verification mark in addition to the first mark!)

Security check carried out:.....

Carried out the company:.....

Name, address of the competent:.....

Result of the Check:

- Initiation not permitted, verification necessary
- Initiation possible, repair failures until.....
- No failings, Initiation possible

.....  
signature of the expert

.....  
signature of the operator

If failures must be repaired:

Failures repaired at: .....signature of the operator  
(Use another form for verification!)

## Regular security check

 Filling out and leave in this manual

kind of check	all right	defect missing	verification	remark
Type plate.....	<input type="checkbox"/>	<input type="checkbox"/>	<input type="checkbox"/>	.....
Short operating instruction.....	<input type="checkbox"/>	<input type="checkbox"/>	<input type="checkbox"/>	.....
Warning designation.....	<input type="checkbox"/>	<input type="checkbox"/>	<input type="checkbox"/>	.....
Sticker "max. capacity".....	<input type="checkbox"/>	<input type="checkbox"/>	<input type="checkbox"/>	.....
Designation lifting/lowering.....	<input type="checkbox"/>	<input type="checkbox"/>	<input type="checkbox"/>	.....
Detailed operating instruction.....	<input type="checkbox"/>	<input type="checkbox"/>	<input type="checkbox"/>	.....
Condition counter.....	<input type="checkbox"/>	<input type="checkbox"/>	<input type="checkbox"/>	.....
Safety device of hinge bolt.....	<input type="checkbox"/>	<input type="checkbox"/>	<input type="checkbox"/>	.....
Condition/Function Ramps.....	<input type="checkbox"/>	<input type="checkbox"/>	<input type="checkbox"/>	.....
Condition automotive lift.....	<input type="checkbox"/>	<input type="checkbox"/>	<input type="checkbox"/>	.....
Condition colour.....	<input type="checkbox"/>	<input type="checkbox"/>	<input type="checkbox"/>	.....
Construction (deformation, cracking) .....	<input type="checkbox"/>	<input type="checkbox"/>	<input type="checkbox"/>	.....
Torque of the dowels .....	<input type="checkbox"/>	<input type="checkbox"/>	<input type="checkbox"/>	.....
torque moments of the screws and dowels.....	<input type="checkbox"/>	<input type="checkbox"/>	<input type="checkbox"/>	.....
Condition operating unit.....	<input type="checkbox"/>	<input type="checkbox"/>	<input type="checkbox"/>	.....
Condition surface piston rod .....	<input type="checkbox"/>	<input type="checkbox"/>	<input type="checkbox"/>	.....
Condition coverings.....	<input type="checkbox"/>	<input type="checkbox"/>	<input type="checkbox"/>	.....
Condition electrical wires .....	<input type="checkbox"/>	<input type="checkbox"/>	<input type="checkbox"/>	.....
Level of hydraulic oil .....	<input type="checkbox"/>	<input type="checkbox"/>	<input type="checkbox"/>	.....
Closeness of the hydraulic system.....	<input type="checkbox"/>	<input type="checkbox"/>	<input type="checkbox"/>	.....
Condition hydraulic hoses.....	<input type="checkbox"/>	<input type="checkbox"/>	<input type="checkbox"/>	.....
Function test with vehicle.....	<input type="checkbox"/>	<input type="checkbox"/>	<input type="checkbox"/>	.....
Function safety devices.....	<input type="checkbox"/>	<input type="checkbox"/>	<input type="checkbox"/>	.....
Condition welding.....	<input type="checkbox"/>	<input type="checkbox"/>	<input type="checkbox"/>	.....
Function/condition slide-guidance.....	<input type="checkbox"/>	<input type="checkbox"/>	<input type="checkbox"/>	.....
Condition runways.....	<input type="checkbox"/>	<input type="checkbox"/>	<input type="checkbox"/>	.....
Condition columns.....	<input type="checkbox"/>	<input type="checkbox"/>	<input type="checkbox"/>	.....
Function CE-Stop.....	<input type="checkbox"/>	<input type="checkbox"/>	<input type="checkbox"/>	.....

( mark here applicable, in case of verification mark in addition to the first mark!)

Security check carried out:.....

Carried out the company:.....

Name, address of the competent:.....

Result of the Check:

- Initiation not permitted, verification necessary
- Initiation possible, repair failures until.....
- No failings, Initiation possible

.....  
signature of the expert

.....  
signature of the operator

If failures must be repaired:

Failures repaired at: .....signature of the operator  
(Use another form for verification!)

## Extraordinary security check

 Filling out and leave in this manual

kind of check	all right	defect missing	verification	remark
Type plate.....	<input type="checkbox"/>	<input type="checkbox"/>	<input type="checkbox"/>	.....
Short operating instruction.....	<input type="checkbox"/>	<input type="checkbox"/>	<input type="checkbox"/>	.....
Warning designation.....	<input type="checkbox"/>	<input type="checkbox"/>	<input type="checkbox"/>	.....
Sticker "max. capacity".....	<input type="checkbox"/>	<input type="checkbox"/>	<input type="checkbox"/>	.....
Designation lifting/lowering.....	<input type="checkbox"/>	<input type="checkbox"/>	<input type="checkbox"/>	.....
Detailed operating instruction.....	<input type="checkbox"/>	<input type="checkbox"/>	<input type="checkbox"/>	.....
Condition concrete.....	<input type="checkbox"/>	<input type="checkbox"/>	<input type="checkbox"/>	.....
Safety device of hinge bolt.....	<input type="checkbox"/>	<input type="checkbox"/>	<input type="checkbox"/>	.....
Condition/Function Ramps.....	<input type="checkbox"/>	<input type="checkbox"/>	<input type="checkbox"/>	.....
Condition automotive lift.....	<input type="checkbox"/>	<input type="checkbox"/>	<input type="checkbox"/>	.....
Condition colour.....	<input type="checkbox"/>	<input type="checkbox"/>	<input type="checkbox"/>	.....
Construction (deformation, cracking) .....	<input type="checkbox"/>	<input type="checkbox"/>	<input type="checkbox"/>	.....
Torque of the dowels .....	<input type="checkbox"/>	<input type="checkbox"/>	<input type="checkbox"/>	.....
torque moments of the screws and dowels.....	<input type="checkbox"/>	<input type="checkbox"/>	<input type="checkbox"/>	.....
Condition operating unit.....	<input type="checkbox"/>	<input type="checkbox"/>	<input type="checkbox"/>	.....
Condition surface piston rod .....	<input type="checkbox"/>	<input type="checkbox"/>	<input type="checkbox"/>	.....
Condition coverings.....	<input type="checkbox"/>	<input type="checkbox"/>	<input type="checkbox"/>	.....
Condition electrical wires .....	<input type="checkbox"/>	<input type="checkbox"/>	<input type="checkbox"/>	.....
Level of hydraulic oil .....	<input type="checkbox"/>	<input type="checkbox"/>	<input type="checkbox"/>	.....
Closeness of the hydraulic system.....	<input type="checkbox"/>	<input type="checkbox"/>	<input type="checkbox"/>	.....
Condition hydraulic hoses.....	<input type="checkbox"/>	<input type="checkbox"/>	<input type="checkbox"/>	.....
Function test with vehicle.....	<input type="checkbox"/>	<input type="checkbox"/>	<input type="checkbox"/>	.....
Function safety devices.....	<input type="checkbox"/>	<input type="checkbox"/>	<input type="checkbox"/>	.....
Condition welding.....	<input type="checkbox"/>	<input type="checkbox"/>	<input type="checkbox"/>	.....
Function/condition slide-guidance.....	<input type="checkbox"/>	<input type="checkbox"/>	<input type="checkbox"/>	.....
Condition runways.....	<input type="checkbox"/>	<input type="checkbox"/>	<input type="checkbox"/>	.....
Condition columns.....	<input type="checkbox"/>	<input type="checkbox"/>	<input type="checkbox"/>	.....
Function CE-Stop.....	<input type="checkbox"/>	<input type="checkbox"/>	<input type="checkbox"/>	.....

( mark here applicable, in case of verification mark in addition to the first mark!)

Security check carried out:.....

Carried out the company:.....

Name, address of the competent:.....

Result of the Check:

- Initiation not permitted, verification necessary
- Initiation possible, repair failures until.....
- No failings, Initiation possible

.....  
signature of the expert

.....  
signature of the operator

If failures must be repaired:

Failures repaired at: .....signature of the operator  
(Use another form for verification!)

## Manual service operation over the keyboard

*Activity only for authorized persons.*

One foil-keyboard and one LC-Display for the position-ad and the service-operation are integrated in the control-box/operating unit.

### 1. After switching on the installation, the following ad appears on the display

Nussbaum Hebetechnik
-------------------------

After 5 seconds, one switches automatically to the position-ad.

### 1. Position-ad

Ad the position of the 4 axes during the normal operation of the lift.

A1-A4: position-value of the 4 axes

<b>A1:</b>	<b>0.0</b>
<b>A2:</b>	<b>0.0</b>
<b>A3:</b>	<b>0.0</b>
<b>A4:</b>	<b>0.0</b>

Step during the business a mistake on, the axis becomes with the mistake through „-E - „in the position-ad marked.

The ad changes between the position-ad and the error message.

Examples:

Ad-statuses with synchronism-mistake of axis 1

<b>A1:</b>	<b>50.3 -E-</b>
<b>A2:</b>	<b>0.0</b>
<b>A3:</b>	<b>0.0</b>
<b>A4:</b>	<b>0.0</b>

<b>Gleichlauffehler</b>
-------------------------

Only when a such mistake was caused, should after telephonic consultation with the Fa. Nussbaum, phone, 0049 (0)7853-899-0 the service-functions, (sees section 4 (service-operating) become used.

With full function-willingness of the automotive-lift, the operating of the service - functions, over the foil-keyboard is forbidden.



### 3. Elapsed time indicator-ad

The number of the working hours can be extract through the operating. Press the button < \* > on the foil-keyboard of the lift.

Ad of the working hours in hours: minute  
Only the time is counted, in which the lift actually drives.

<b>Betriebsstunden</b> <b>0000000:00 h</b>
---

The return to the position-ad takes place automatically anuses approximately 15 seconds or through operates of the < \* > -button.

*Function button:*

< \* > Return to the position-ad (2).

### 4. Service-operation

The service operation is used for it, during the initiation (installation) or to do the lift after a disturbance in function again. Only for these two cases, this operating mode of the lift is intended. Is not allowed to activate these functions, if the lift has the normal function. The functions of the service operation can be activated over the foil-keyboard appropriate on the switchbox. To the navigation in the menu system of the service functions serves the buttons:

< \* > **menu-point**

< # > **confirms the menu-point**

Through presses and confirming " zurück " you can go back from a submenu into the higher ranking menu again.

#### 4.1 Log-in in the service-operation

The operator must log-in in the service-operation to activate the service-functions. He presses during the position-ad the button # and inputs afterwards SERVICE-PIN. After correct input the PIN takes place automatically the change into the service-main menu.

Retrieval of the password for service-functions

<b>Password</b> - - - -
----------------------------

Default-value of the password is ' 1234 '.

This can be altered with demand over the PC-Software, the new password is secured durably with it in the FRAM of the „Achscntrollers“.

*Function button:*

< \* > Back to the position-ad (2).

< 0 > ... < 9 > password input

## 4.2 Service-Menu

Dialed menu-point becomes through > < marked

<p>&gt;Gesteuert&lt; Achse nullen Hubhöhe zurück</p>
--

*Function button:*

< \* > next menu-point dials

< # > menu-point activates

The menu-point becomes > zurück < activated jumps back this to the position-ad.

## 4.3 STEERED

Both axes of the lift can be driven individually over the function " GESTEUERT ". The driven axis becomes over "\*" "marks and demarcates and after it over „#"“activates. This function can be used only in the disturbance-case!

controlled operation - axis 1 active

*1*	50.3
2	0.0
3	0.0
4	0.0

The controlled business over the ad-functions is only possible if the dip-switch stands 5 on the "Achskontroller" on "ON"!

If the dip-switch 5 is standing on "OFF", the axe drives over the dip-switch-attitude, independently from the ad-function.

Over the buttons < 1 >, < 2 >, < 3 >, < 4 > is dialed the axes, the steered procedures should become. The dialed axes become on the ad through \*X\* marks.

If the button < lifting > or < lowering > was pressed afterwards, only the select axe can moved.

**! The installation can become destroyed.**

*Function button:*

< \* > Abortion and return into the service-menu (4.2)

< 1 > axe 1 activates / deactivates

< 2 > axe 2 activates / deactivates

< 3 > axe 3 activates / deactivates

< 4 > axe 4 activates / deactivates

## 4.4 Reset of the measuring systems

Over this function, the entire measuring-system of the lift can be put back, (zero). This function is allowed to only after consultation with the service-headquarters of the Fa. Nussbaum (phone) + 49 (0)7853-899-0.

Achse nullen?

Alert message, whether axes should really become reset.

With confirmation of the retrieval with < # > is put down the axes on zero and is jumped back automatically to the position-ad (2) afterwards.

That zeros of the axes is only possible, if the dip-switch 5 on the „Achskontroller“ stands on „ON“.

**! The installation can become destroyed.**

*Function button:*

< \* > Abortion and return into the service-menu (4.2)

< # > axes becomes on zero favored

## 4.5 Altitudes restricts

The maximum lifting of the lift can be restricted over the menu-point " HUBHOEHE ".

The indicated value can over the button < 1 > increment and over the button < 0 > decrement becomes. After election of the desired lift, becomes over < # > the value taken on. The submenu was deserted.

The submenu was deserted with the button and the changed value was not stored.

*Function button:*

< \* > **Demolition and return into the service-menu without stores**

< # > store the new value and return into the service-menu

< 1 > Increases the lifting height

< 0 > Reduces the lifting height

## 4.6 going back

From a submenu, one can come back into the paramount menu again. Press the button "ZURÜCK".

## Hydraulic diagram drawing

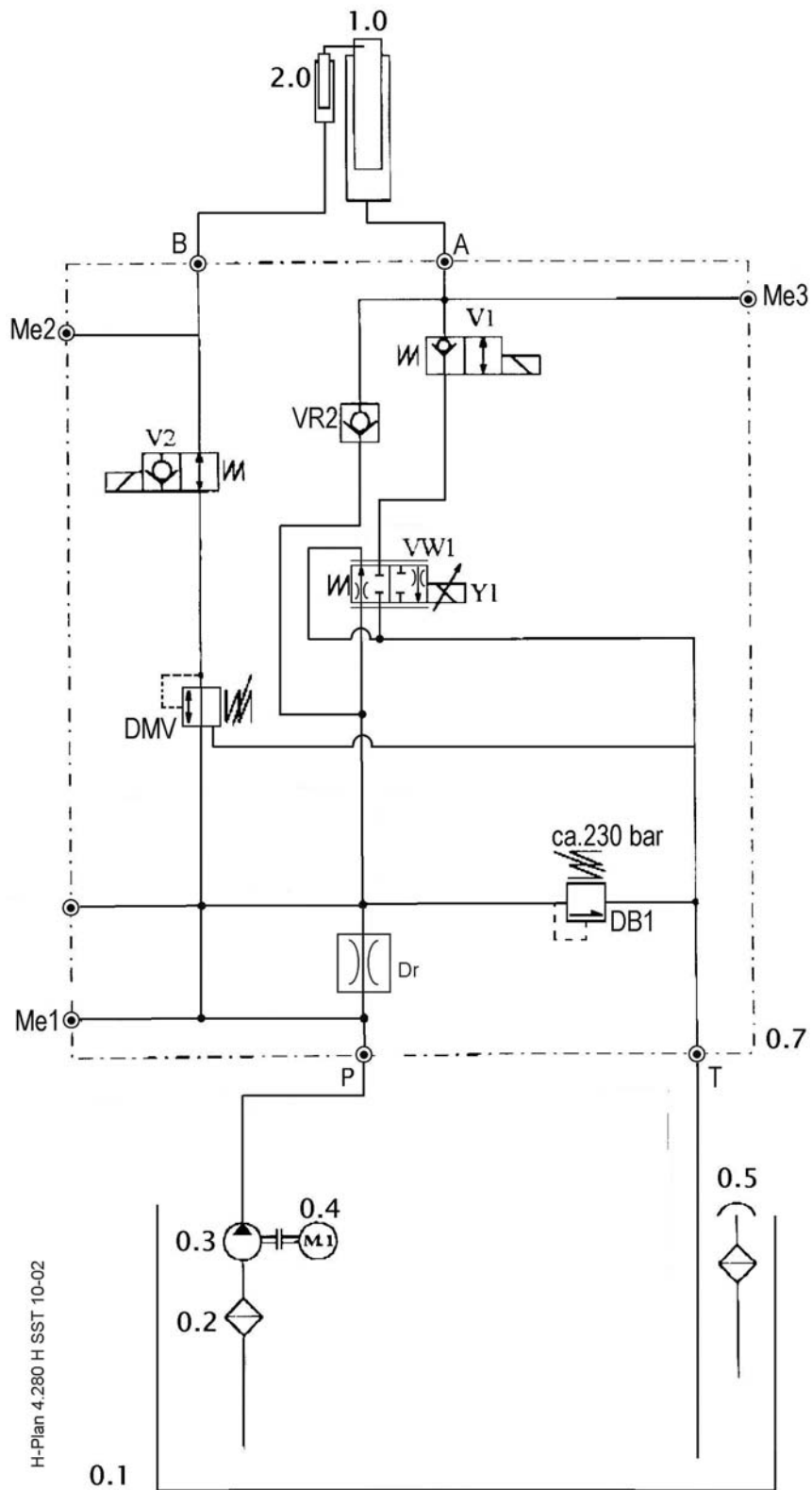

## Hydraulic parts list

<b>Pos.</b>	<b>Description</b>	<b>order number</b>
0.1	oil tank	
0.2	oil filter	980012
0.3	gear pump	980486
0.4	suboilmotor	991033
0.5	oil level gauge	980098
0.7	hydraulic block complete	99 540 06 00 5
DB1	pressure relief valve 230 bar	155211
DMV	pressure relief valve 30 bar DR08-01-C-V-120V	161350
M1-M3	measure connection	118495
VW1	proportional valve WEP06DA1380240S	161060
DR	lowering valve Ø 1,3 mm	161576
V1	2/2 way valve	158502
V2	2/2 way valve	158503
VR2	holding valve	130053
1.0	cylinder	
2.0	safety device cylinder	

**Electrical diagram drawing**  
(valid for 4.80 H SST – 4.300 H SST)

0	1	2	3	4	5	6	7	8	9																
					<h1 style="text-decoration: underline double;">SCHALTPLAN</h1>																				
<p>Vor Inbetriebnahme Verdrahtung und Steuerung auf richtige Funktion</p>					<p>OBJEKT : 4.280 H SST ANLAGE : KUNDE : SCHALTPLANNR: 280 H SST/04/02/001</p>																				
<p>worden, halten, bitten wir,</p>					<p>Der Schaltschrank wurde unter Beachtung der anerkannten Regeln der Technik nach  nach VDE0100gr7.75 Par.22.</p>																				
<p>Nussbaum Hebeteknik GmbH &amp; Co.KG D-77694 Kehl-Bodersweiler Tel.: +49(0)7853/899-0 Fax.: +49(0)7853/8787</p>					<p>4.280 H SST</p>																				
<table border="1" style="width: 100%; border-collapse: collapse;"> <tr> <td style="width: 15%;">Datum</td> <td style="width: 15%;">27.05.02</td> <td style="width: 15%;">Inhaltsverzeichnis</td> <td style="width: 15%;">4.280 H SST 04/02/001</td> </tr> <tr> <td>Bearb.</td> <td>Boe</td> <td>=</td> <td>Blatt 1</td> </tr> <tr> <td>Gepr.</td> <td></td> <td>+</td> <td>von 12</td> </tr> <tr> <td>Norm</td> <td></td> <td></td> <td>Bl.</td> </tr> </table>					Datum	27.05.02	Inhaltsverzeichnis	4.280 H SST 04/02/001	Bearb.	Boe	=	Blatt 1	Gepr.		+	von 12	Norm			Bl.	<p>Zust.</p>				
Datum	27.05.02	Inhaltsverzeichnis	4.280 H SST 04/02/001																						
Bearb.	Boe	=	Blatt 1																						
Gepr.		+	von 12																						
Norm			Bl.																						







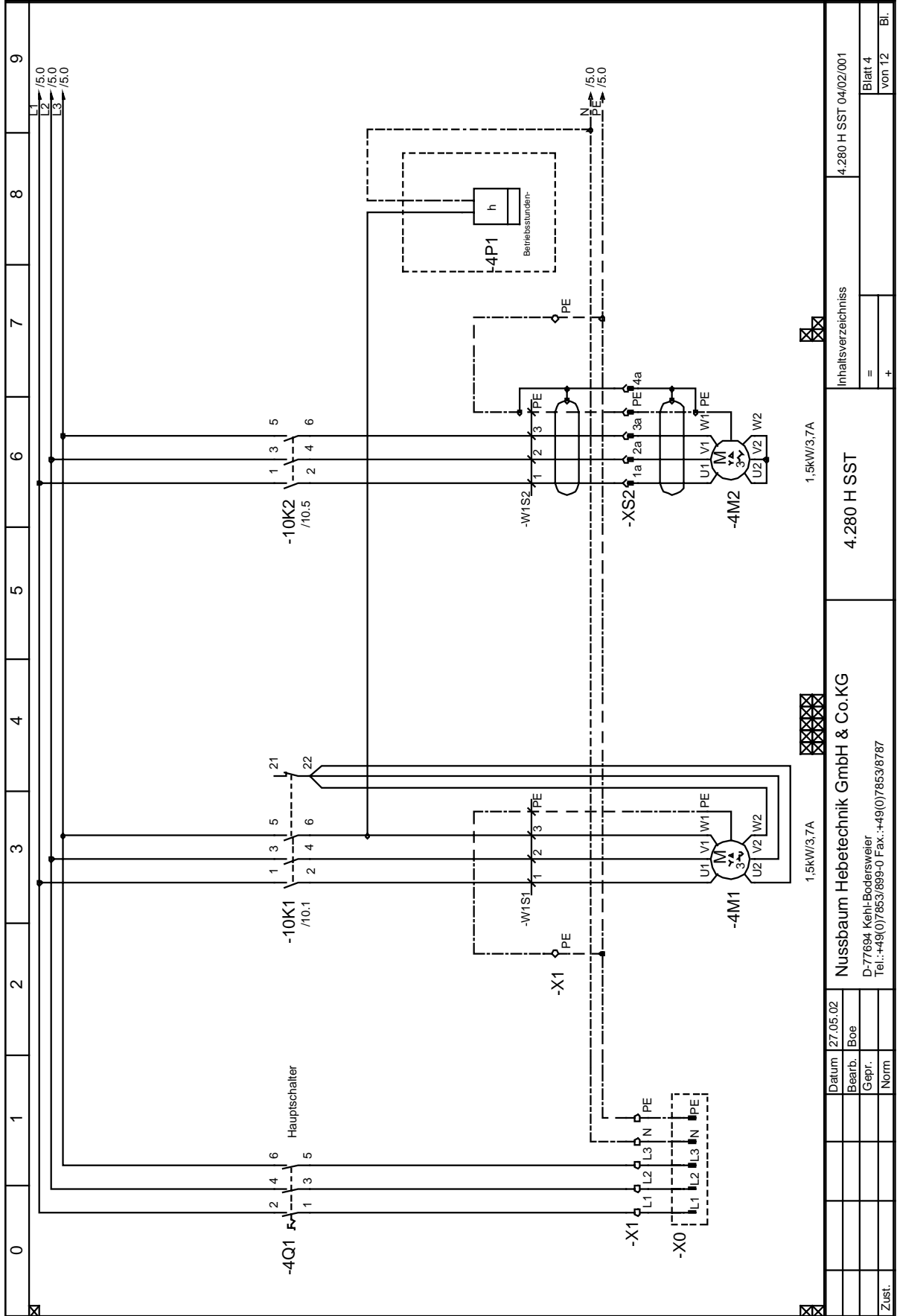

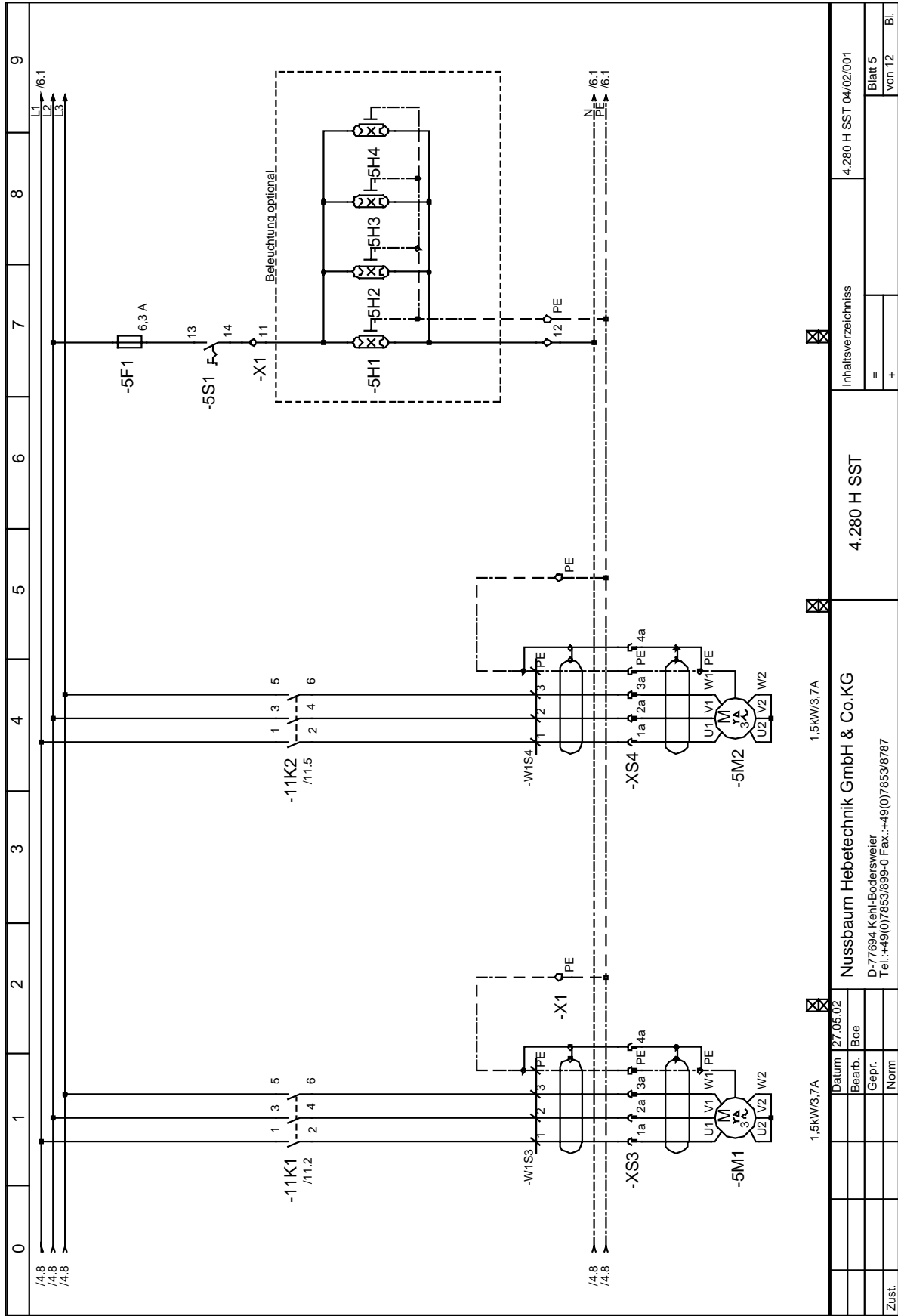

Zust.		Datum 27.05.02		1.5kW/3.7A		1.5kW/3.7A		4.280 H SST		Inhaltsverzeichnis		4.280 H SST 04/02/001	
Norm		Boe		X		X		X		=		Blatt 5	
										+		von 12	

Nussbaum Hebeotechnik GmbH & Co.KG  
D-77694 Kehl-Bodersweiler  
Tel.: +49(0)7853899-0 Fax.: +49(0)78538787

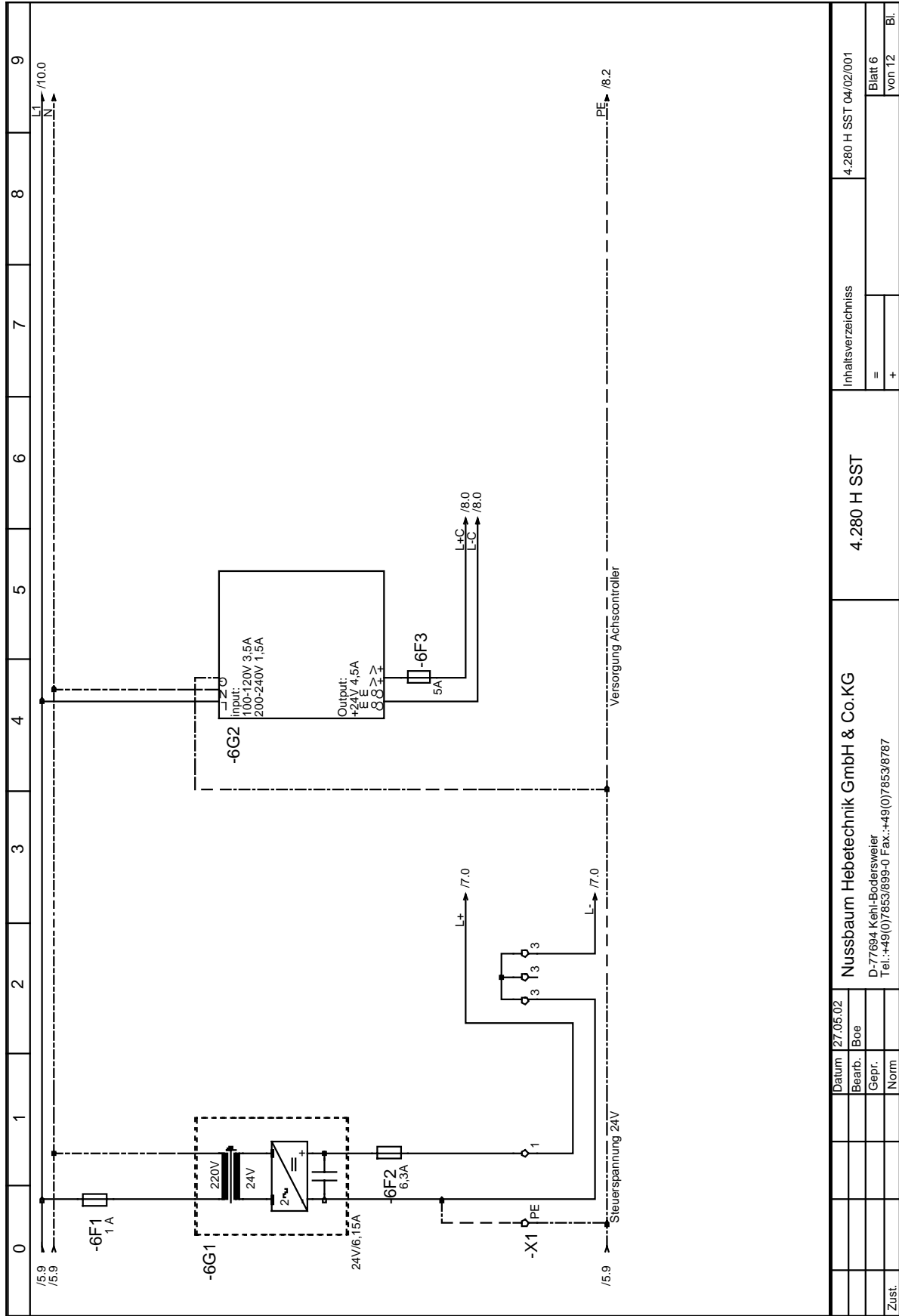

Datum		27.05.02		Inhaltsverzeichnis		4.280 H SST 04/02/001	
Bearb.	Boe					Blatt 6	
Gepr.						von 12	
Norm						Bl.	
Zust.							
Nussbaum Hebeotechnik GmbH & Co. KG				4.280 H SST			
D-77694 Kehl-Bodersweiler							
Tel.:+49(0)7853899-0 Fax.:+49(0)78538787							

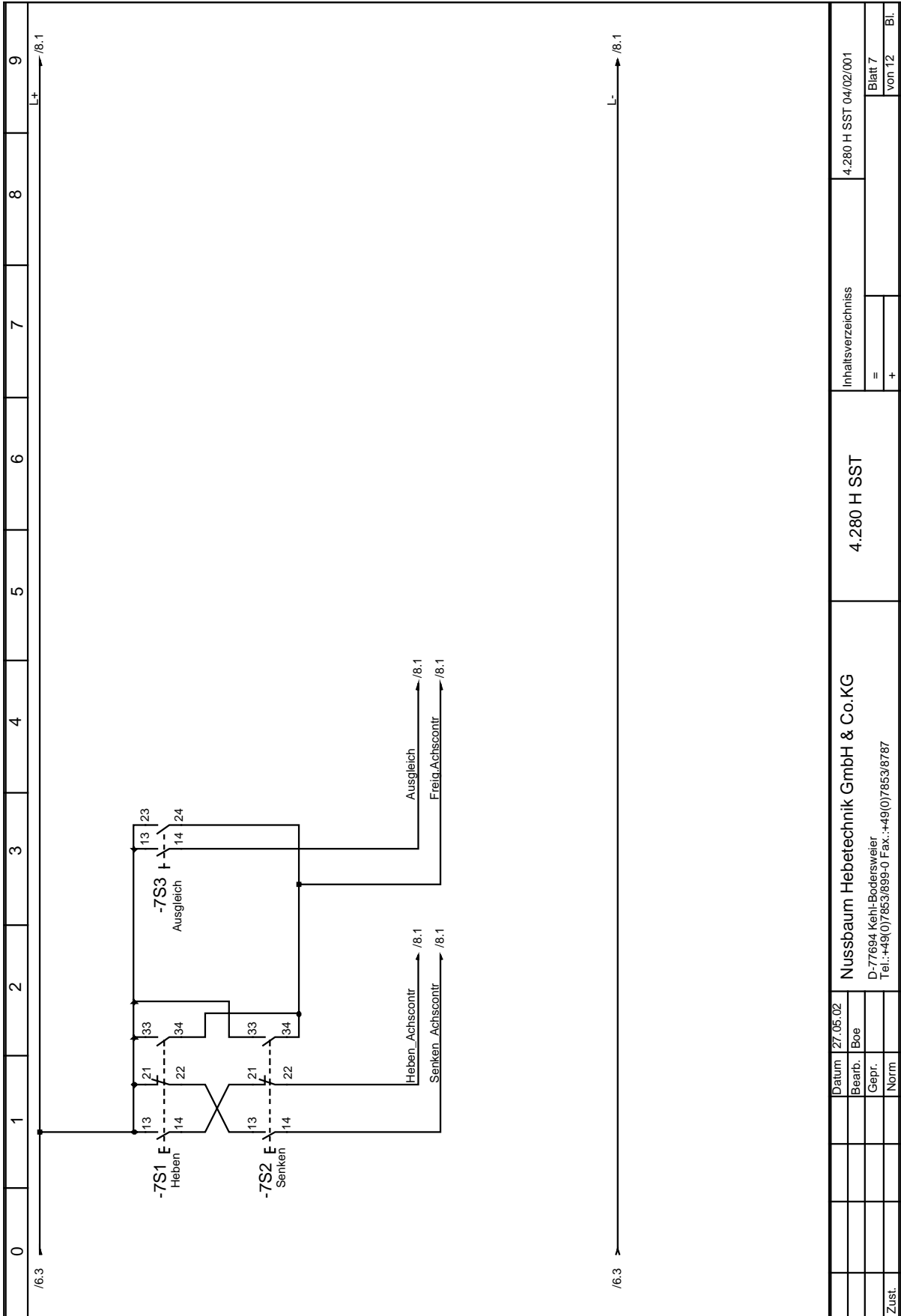

Zust.		Datum		27.05.02		Inhaltsverzeichnis		4.280 H SST 04/02/001			
		Bearb.		Boe		=		Blatt 7			
		Gepr.				+		von 12			
		Norm						Bl.			
Nussbaum Hebeteknik GmbH & Co.KG				4.280 H SST							
D-77694 Kehl-Bodersweiler Tel.: +49(0)7853899-0 Fax.: +49(0)78538787											





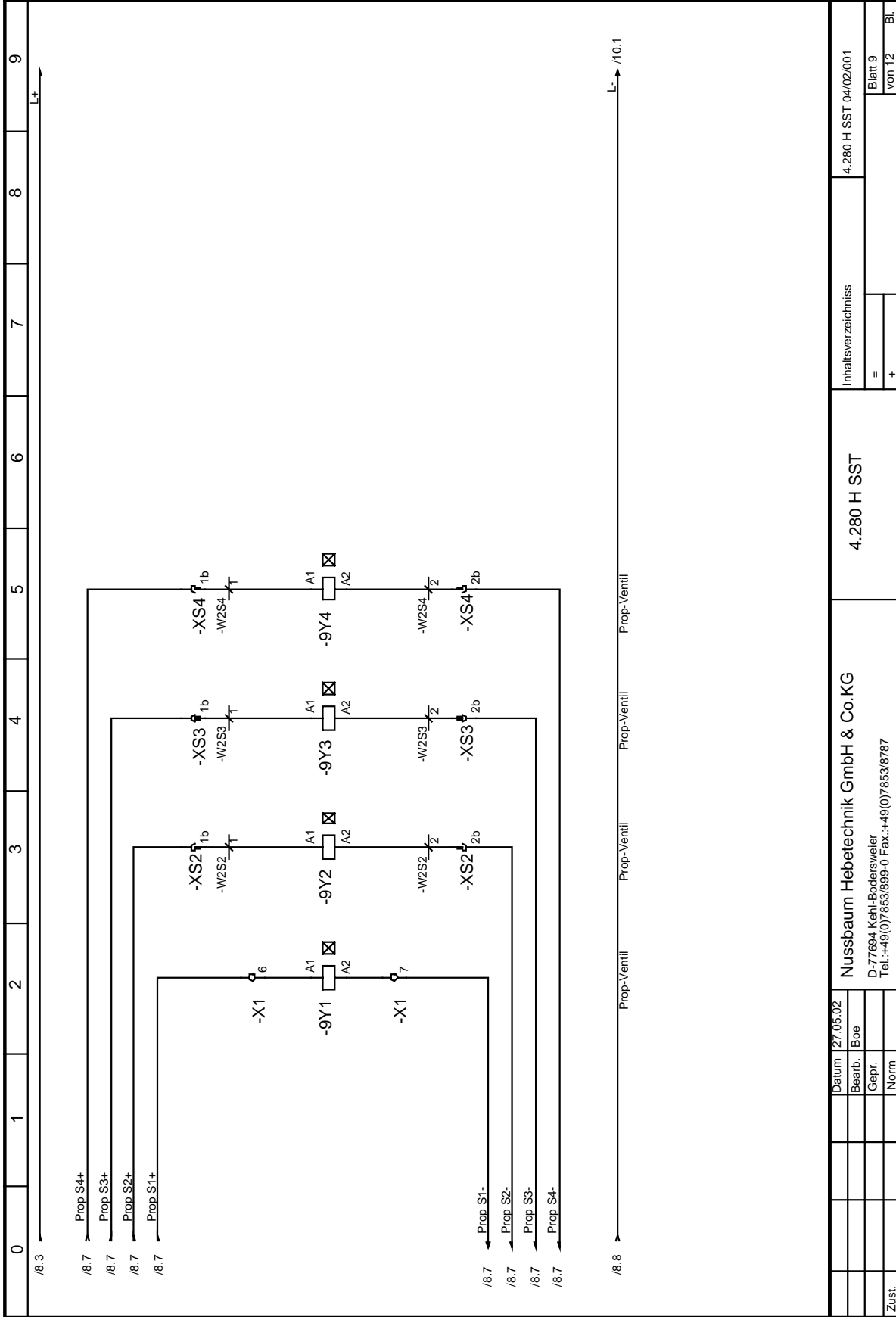

	Datum	27.05.02		4.280 H SST	Inhaltsverzeichnis
	Bearb.	Boe			=
	Gepr.				+
	Norm				Bl. 9
Zust.					von 12
					Bl.

**Nussbaum Hebeteknik GmbH & Co. KG**  
D-77694 Kehl-Bodersweiler  
Tel.: +49 (0)7853899-0 Fax: +49 (0)78538787

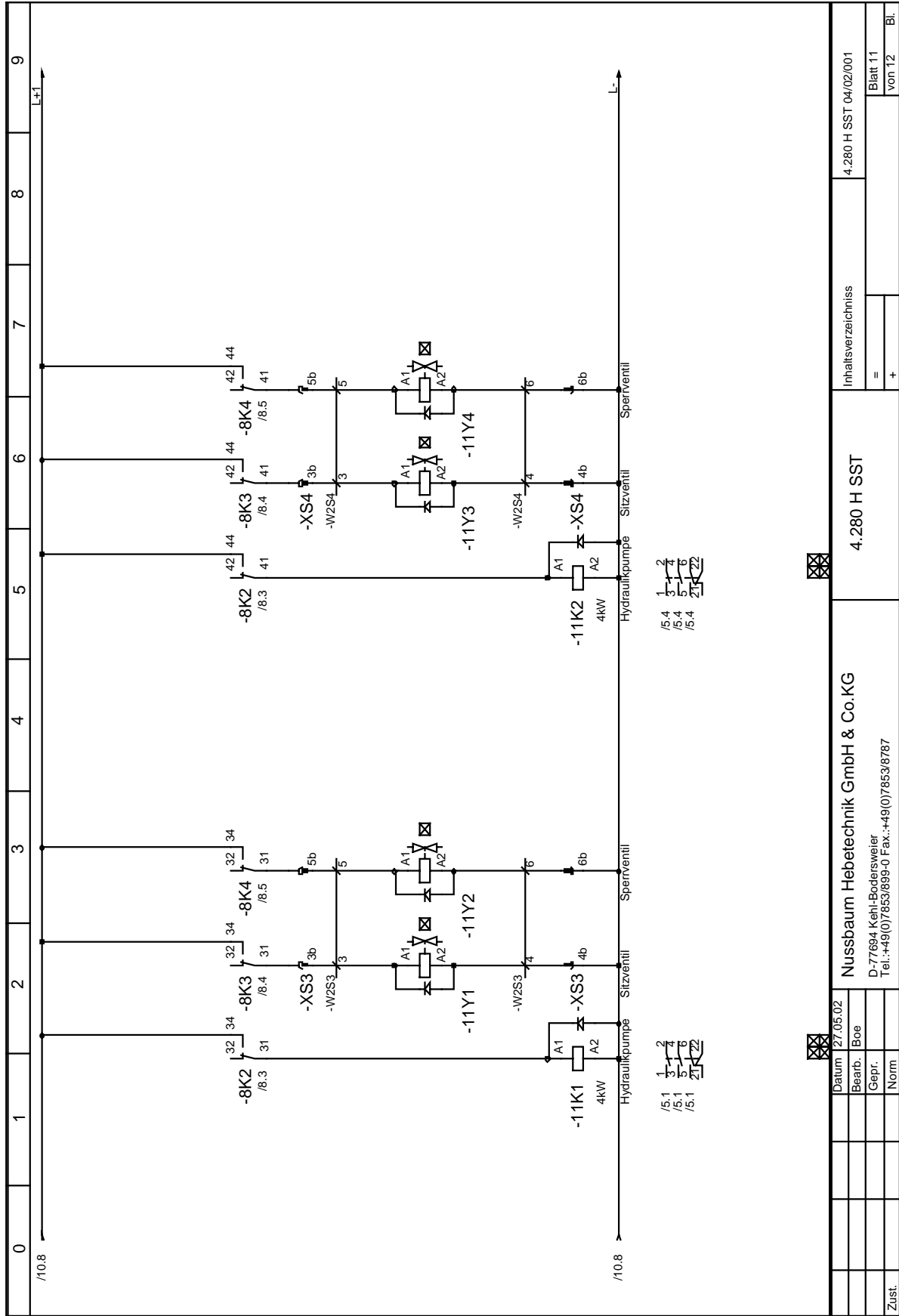

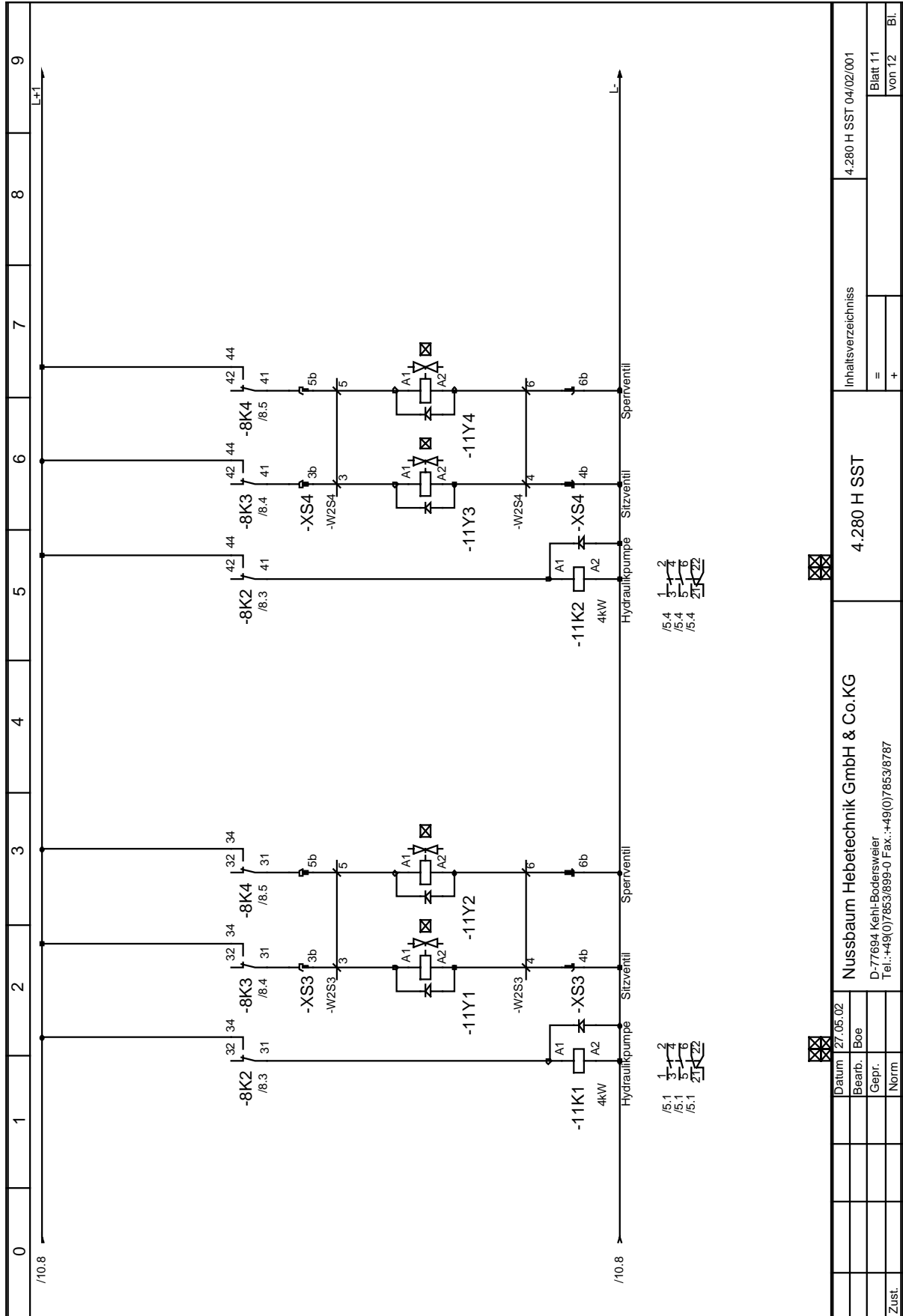

Zust.		Norm		Gepr.		Bearb. Boe		Datum 27.05.02		Nussbaum Hebetchnik GmbH & Co.KG		4.280 H SST		Inhaltsverzeichnis		4.280 H SST 04/02/001	
										D-77694 Kehl-Bodersweiler				=		Blatt 11	
										Tel.: +49(0)7853899-0 Fax.: +49(0)78538787				+		von 12	

0	1	2	3	4	5	6	7	8	9										
										Datum	27.05.02								
										Bearb.	Boe								
										Gepr.									
										Norm									
										Zust.									
										Nussbaum Hebetchnik GmbH & Co.KG		4.280 H SST		Inhaltsverzeichnis				4.280 H SST 04/02/001	
										D-77694 Kehlbodenweiler				=				Blatt 12	
										Tel.: +49(0)7853/899-0 Fax.: +49(0)7853/8787				+				von 12 Bl.	

Materialliste				material list				Liste de Materiel				
Idt.Nr. Nr. N°	Anz. Pièces Nombre	Bezugsnamen Identificateur	Art.Nr. article, Nr. N° Art.	Beurteilbezeichnung designation	Hersteller Fabricateur Fournisseur	Hersteller Nr. numéro Fournisseur Nr.						
1	1	-8A2	940257		Display Elek.	DEM16481 SY-LY/I						
	1		990874	Displaykabel	I/P GmbH	Kabel 16polig						
	1		990690		Gronau							
2	1	-8E1	991416		Hiller GmbH	046R64LG3 042641103						
	44		991352			45365.123.204						
	44		991353			F 2,8						
3	1	-8E2	940265		Tastaturkabel	113-9503						
	1		990875			Kabel 10polig						
4	3	-8K2, -8K3, -8K4	990267	Industrierelais 4W 24V	BTR	274i						
	3		990381	Industrierelaissockel 4 W	Finder	94.74.1						
5	1	-6F1	990661	Sicherungsklemme Trenner 5*20 mm M4/8. SF	Entrelec Schiele	0115657.25						
	1		990475		Streb	Feinsicherung 1A						
6	1	-6F3	990661	Sicherungsklemme Trenner 5*20 mm M4/8. SF	Entrelec Schiele	0115657.25						
	1		990307		Streb	Feinsicherung 5 A						
7	2	-5F1, -6F2	990661	Sicherungsklemme Trenner 5*20 mm M4/8. SF	Entrelec Schiele	0115657.25						
	2		990286		Streb	Feinsicherung 6,3 A						
8	3	-XH2, -XH3, -XH4	990919		RS	172-9077						
	3		990918		RS	172-8951						
	18		991330			172-9140						
	18		991331			172-9134						
				Materialliste				4.280 H SST				
				Nussbaum Hebeteknik GmbH & Co.KG				4.280 H SST 04/02/001				
				D-77694 Kehlbodenweiler				Blatt 1				
				Tel.:+49(0)7853/899-0 Fax: +49(0)7853/8787				von 5				
								Bl.				

Materialliste			material list			Liste de Materiel		
lfd. Nr. N° N°	Anz. pièces Nombre	Bezugsnamen références identificateur	Art. Nr. article, Nr. N° Art.	Bezeichnung designator	Hersteller manufacture Fournisseur	Hersteller Nr. manufacturer n° Fournisseur N°		
9	16	-8D1, -8D2, -8D3, -8D4 -10D1, -10D2, -10D3 -10D4, -10D5, -10D6 -11D1, -11D2, -11D3 -11D4, -11D5, -11D6	990652	Sperrelaade 1N40007 1000V/1A	Conrad Elektron			
10	1	-8H1	990331	Digisond akustischer Signalgeber	Deltron Compon	B/P 228		
11	4	-4M1, -4M2, -5M1, -5M2	991033		ELMA Elektromot.	AT 80B-4		
12	1	-X1	990185	Schutzleiterkl D 2,5/8.P.ADO GR/GE schrn-schn	Entrelec Schiele	0199091.17		
13	4	-X1	990578	Schutzleiterkl D 1,5/6.P.ADO GR/GE schrn-schn	Entrelec Schiele	0199098.26		
14	4	-X1	990593	Univ.klemme D 6/8.ADO grau schraub-schn	Entrelec Schiele	0199042.25		
15	1	-X1	990594	Schutzleiterkl D 6/8.P.ADO GR/GE schraub-schn	Entrelec Schiele	0199118.26		
16	1	-X1	990679	Mini-SL-Klem DR 2,5/8.P.ADO GR/GE schrn-schn 15m	Entrelec Schiele	0299633.06		
17	14	-X1	990702	Mini-Klemme DR 1,5/6.ADO grau schrn-schn 15mm	Entrelec Schiele	0199283.24		
18	1	-8A1	940260	Achscontroller ASC 4000	IVP GmbH	ASC 4000		
19	4	-8B1, -8B2, -8B3, -8B4	990658	HALLELEMENTSCHALTER HDD-16MS60BL,5-55ND1/5	Kalaszka			
20	2	-7S1, -7S2	990130	Drucktaete fl. o.Tast.Pl.(M22)		M22-DIL-X		
	2		990131	Tastenplatte Pfeil (M22)		M22-XD-S-X7		
	2		990132			M22-AK11		
	2		990133	Kontaktelement 1S (M22)		M22-K10		
21	1	-7S3	990130	Drucktaete fl. o.Tast.Pl.(M22)		M22-DIL-X		
				Nussbaum Hebeteknik GmbH & Co.KG		4.280 H SST		
				D-77694 Kehl-Bodersweiler Tel.:+49(0)7853899-0 Fax.:+49(0)78538787		Materialliste		
				Datum   27.05.02		4.280 H SST 04/02/001		
				Bearb.   Boe		Blatt 2		
				Gepr.		von 5		
				Norm		Bl.		



Materialliste				material list				Liste de Materiel				
Id.Nr. Nr. Nr.	Anz. Nombre	Bezugsnamen identificateur	Art.Nr. Nr. Art.	Bezeichnung designation	Hersteller Fournisseur	Hersteller Nr. nr. Fournisseur Nr.						
	1		990965	Befestigungsadapter (M22)		M22-A						
	2		990133	Kontaktlement 1S (M22)		M22-K10						
	1		991045	Tastenplatte Start (1)(M22)		M22-XD-G-X1						
22	1	-5S1	991051	Wahlaste 2St. Knebel rast.(M22)		M22-WRK						
	1		990142	Kontaktblock 1S (M22)		M22-AK10						
23	5	-8K1, -10K1, -10K2	990842		Lovato	BG12.01 (24V DC)						
		-11K1, -11K2										
24	1	-4Q1	991032	Hauptsch. Not-Aus 3p 20A 7,5kW	Merz	MZ						
25	1	-8S1	990366	Drucktaaster Einbau klein 1S	Oser	DS 131						
26	3	-XS2, -XS3, -XS4	1771383			1771383						
	3		990833			1677746						
	3		990822			1663462						
	3		990821			1663459						
	6		990824			1663323						
	6		990823			1663310						
	3		990826			1663608						
	3		990825			1663679						
27	3	-XS2, -XS3, -XS4	990819			1679252						
	3		990820			1679294						
28	21	-XS2, -XS3, -XS4	990827			1674480						
		Datum	27.05.02	Materialliste				4.280 H SST				4.280 H SST 04/02/001
		Bearb.	Boe									Blatt 3
		Gepr.										von 5
		Norm										Bl.
Zust.				Nussbaum Hebeteknik GmbH & Co.KG								
				D-77694 Kehl-Bodersweiler								
				Tel.:+49(0)7853899-0 Fax.:+49(0)78538787								

Materialliste			material list			Liste de Materiel		
Idt. Nr. Nr. Nr.	Anz. Pièce Nombre	Bezugsnamen identificateur	Art.Nr. article, Nr. Nr. Art.	Bauteilbezeichnung designation	Hersteller fabricateur Fournisseur	Hersteller Nr. numérateur Fournisseur Nr.		
	21		990828			1672453		
29	18	-XS2, -XS3, -XS4	990829			1663420		
	18		990830			1663365		
30	9	-XS2, -XS3, -XS4	990825			1663679		
	9		990826			1663608		
31	1	-4J1	991364	EB Elektro-Box gr. m. MIPi. 300x400x155	Rittal	EB1577.600		
32	1	-6G1	990835	Trato 1-ph + Gleichrichter+ C 230V/24V DC 6,15A	Schmelzer	MSE 84/29,5 5371		
33	4	-9Y1, -9Y2, -9Y3, -9Y4	155689	Proportionalventil	Seehausen	155689		
34	4	-10Y1, -10Y3, -11Y1	3000249	Sitzventilspule 24 V / 0,8 A, 29,9 Ohm	Seehausen			
		-11Y3						
35	4	-10Y2, -10Y4, -11Y2	BM 4513604LOA	Wegeventilspule 24 V / 0,72 A, 100% ED	Seehausen			
		-11Y4						
36	12	-9E1, -9E2, -9E3, -9E4	990654	Leitungsdose / Ventilstecker	Stifel	PG11 C18211 N21		
		-10E1, -10E2, -10E7						
		-10E8, -11E5, -11E6						
		-11E11, -11E12						
37	3	-10E6, -11E4, -11E10	990005	Konusverschraubung PG 11	Streb	311 PG		
38	1	-4E4	990006	Gegenmutter PG 11 Messing	Streb	PG 11		
39	1	-4E2	990012	Gegenmutter PG 13,5 Messing	Streb	PG 13,5		
40	5	-4E6, -4E8, -4E10	990110	Gegenmutter PG 9 Messing	Streb	PG 9		
			Materialliste			4.280 H SST 04/02/001		
			Nussbaum Hebetchnik GmbH & Co.KG			4.280 H SST		
			D-77694 Kehl+Bodersweiler			Blatt 4		
			Tel.:+49(0)7853/899-0 Fax: +49(0)7853/8787			von 5		
Zust.						Bl.		
			Datum	27.05.02				
			Bearb.	Boe				
			Gepr.					
			Norm					

