

4.80 H

Automotive-Lift date 12/2002

Manual date: 01.08.2012



Original Documentation

Operating Instruction and Documentation

Serial-number:.....

Retailer address / phone



Nussbaum

Otto Nußbaum GmbH & Co. KG//Korker Straße 24//D-77694 Kehl-Bodersweier//Tel: +49(0)7853/8990 Fax:
+49(0)7853/8787//E-Mail: info@nussbaum-lifts.de//<http://www.nussbaum-lifts.de>

Inhalt

Foreword	3
Record of installation	5
Record of handing over	6
1 General Information	7
1.1 Installation and service checks of the automotive lift	7
1.2 Warning Symbols	7
2 Master document of the automotive lift	8
2.1 Lift–manufacturer	8
2.2 Application	8
2.3 Changes at the construction	8
2.4 Displacement of the automotive-lift	8
2.5 Declaration of Conformity	9
3 Technical Information	10
3.1 Technical ratings	10
3.2 Safety device	10
3.3 Data sheet	11
3.4 Foundation diagram drawing	12
3.5 Hydraulik diagram drawing	14
3.6 Electrical diagram feed in	15
3.7 Electrical diagram control system	16
3.8 Connection–command (picture)	17
4 Safety regulations	20
5 Operating Instructions	20
5.1 Lifting the vehicle	20
5.2 Lowering the vehicle	21
5.3 Lower the lift into the safety ratchets	22
5.4 Adjusting the platform	22
6 Troubleshooting	23
6.1 Lowering onto an obstacle	24
6.2 Emergency lowering	24
7 Inspection and Maintenance	25
7.1 Maintenance plan of the lift	26
7.3 How often must the lift be cleaned?	27
8 Security check	28
9 Handing over and Initiation	29
9.1 Regulations	29
9.2 Erection and bolting down the lift	29
9.3 Change of lift location	31
9.4 Initiation	32
First security check before installation	36
Regular security check and Maintenance	37
Extraordinary security check	44

Foreword

Nußbaum lifting systems are the result of over 25 years experience in the automotive lifting industry.

The high quality and the superior concept ensure reliability, a long lift lifetime and above all and economic business solution.

To avoid unnecessary damage, injury or even death, read the operating instructions with care and observe the contents.

Nußbaum lifts is not responsible for incidents involving the use of Nußbaum lifting systems for applications other than those for which they were designed.

Otto Nußbaum GmbH & Co. KG is not liable for any resulting damages. The user carries the risk alone.

Obligations of the user:

- To observe and adhere to the operating instructions.
- To follow the recommended inspection and maintenance procedures and carry out the prescribed tests.
- The operating instructions must be observed by all persons working with or around the lift.
- Above all chapter 4 "Safety Regulations" is very important and must be closely adhered to.
- In addition to the safety regulations stated in the operating instructions manual, the appropriate safety regulations and the operating procedures of the place of operation must also be considered.

Obligations of the operator:

The operator is obliged to allow only those persons complying to the following requirements to work with or around the unit.

- Persons being familiar with the basic regulations concerning labour safety and accident prevention and being trained to operate the particular unit.
- Persons having read and understood the chapter concerning safety and warning symbols.
- Persons using the lift are required to confirm that they have read and understood the chapter on safety and warning symbols by signing the appropriate form.

Dangers when operating the lift:

Nußbaum-Lifts are designed and built according to technical standards and the approved regulations for technical safety. The use of Nußbaum lifts for purposes other than those for which they were designed, may result in injury or even death.

The lift must only be operated :

- For its appropriate use
- In faultless condition concerning technical security.

Organisational Requirements

- The instructions for use are to be kept at the place of operation being easily accessible at any time.
- In addition to the instructions for use, rules pertaining to other regulations i.e. accident prevention and environmental rules are to be observed and adhered to.
- The owner of the Nußbaum lifting system must ensure that operators and persons working with or around the lift occasionally conduct “refresher” courses to ensure that the appropriate operating procedures and safety precautions are known.
- Personal Protective Equipment (PPE) must be used according to the appropriate regulations.
- All safety- and danger signs on and around the lift are to be observed and followed!
- Spare parts must comply with the technical requirements specified by the manufacturer. This is only warranted with original parts.
- Observe and adhere to the specified time intervals between tests and inspections.

Maintenance works, repairing faults

- Adjustments, maintenance, and inspections, are to be followed according to the time intervals specified. Details regarding the exchange of parts and components as mentioned in the operating instructions are to be adhered to.
These works must only be carried out by expert personal.
- After maintenance- and repair works loose screws, nuts and bolts must always be firmly tightened!

Guarantee and liability

- Our “General conditions of selling and delivering” are in force.
There will be no guarantee or liability for incidents involving injuries or death or damage to equipment if these incidents are the result of one or more of the following reasons.
- Inappropriate use of the lift
- Inappropriate installation, initiation, operation and maintenance of the lift.
- Use of the lift while one or several security devices do not work, do not work correctly or are not installed correctly.
- Failure to follow the regulations of the operating instructions regarding transport, storage, installation, initiation, operation and maintenance of the lift.
- Unauthorized changes to the structure of the lift without first asking the producer.
- Unauthorized changes of adjustments of important components of the lift (e.g. driving elements, power rating, motor speed, etc)
- Wrong or incorrect maintenance practice.
- Catastrophes, acts of God or external reasons.



After completely filling out this sheet including signatures, copy and return the original to the manufacturer. The copy must remain in the manual..

Otto Nußbaum GmbH & Co. KG
Korker Straße 24
D-77694 Kehl-Bodersweier

Record of installation

The automotive lift 4.80 H with the

serial number:..... was installed on:.....

at the firm:..... at:.....

The initial safety check was carried out and the lift was started.

The installation was carried out by the operating authority/competent (please delete as applicable).

The initial safety check was carried out by a competent person before the initial operation.

The operating authority confirms the correct installation of the automotive lift, the competent person confirms the correct initial operation.

.....
date	name of the operating authority	signature of the operating authority

.....
date	name of the competent person	signature of the competent person

Your customer service:.....(stamp)

Record of handing over

The automotive lift 4.80 H with the
serial number:..... was installed on:.....
at the firm:..... at:.....
the safety was checked and the lift was started.

The persons below were introduced after the installation of the automotive lift. The
introduction was carried out by either the erector from the lift-manufacturer or from a
franchised dealer (competent person).

.....
date name signature

.....
date name signature

.....
date name signature

.....
date name signature

.....
date name signature

.....
date name signature

.....
date name of competent signature of the competent

Your customer service:.....(stamp)

1 General Information

The document “**Operating Instructions and Documentation**” contains important information about installation, operation and maintenance of the automotive lift.

- Conformation of **installation of the automotive lift** is recorded on the ”Record of Installation” form and must be signed and returned to the manufacturer.
- Conformation of once of, regular and out of the ordinary service checks is recorded in the respective check forms. The forms are used to document the checks. They should not be removed from the manual.

All **Changes to the structure** and any change of **location** of the automotive lift must be registered in the ”**Master document**” of the lift

1.1 Installation and service checks of the automotive lift

Only specialised staff are allowed to repair and maintain the lift and only these specialised staff are allowed to conduct safety checks on the lift. For the purposes of this document these specialised staff will be called Experts and Competent persons.

Experts are persons (for example self-employed engineers, experts) which have received instructions and have the appropriate experience to check and to test the automotive lifts. They are aware of the work involved and know the accident prevention regulations.

Competent persons are persons who have acquired adequate knowledge and experience with automotive lifts. They have completed the appropriate training provided by the lift-manufacturer (the servicing technicians of the manufacturer or dealer, are regarded as competent)

1.2 Warning Symbols

The three symbols below are used to indicate danger and other important information. Pay attention to areas on and around the lift that are marked with these symbols.



Danger! This sign indicates danger. Ignoring this warning may result in injury or even death.



Caution! This sign cautions against possible damage to the automotive lift or other material objects in the case of improper use .



Attention! This sign indicates an important function or other important information regarding the operation of the lift.

2 Master document of the automotive lift

2.1 Lift–manufacturer

Otto Nußbaum GmbH & Co. KG
Korker Straße 24
D-77694 Kehl-Bodersweier

2.2 Application

The automotive lift 4.80 H is a lifting mechanism for lifting motor vehicles with a laden weight of up to 8000 kg . The max. load distribution is 2:1 either in or against the drive-on direction.

The automotive lift has been designed for servicing vehicles only. It has not been designed to carry people. Carrying people either directly on the lift or in vehicles that are on the lift is therefore not allowed.

The installation of the standard lift in hazardous or dangerous locations such as wash bays is dangerous and is therefore not allowed.

Changes of construction, repairing and changes of place must be registered in this master document.

2.3 Changes at the construction

Changes at the construction, expert checking, resumption of work (date, kind of change, signature of the expert)

.....
.....
.....
.....

name, address of the expert

.....
place, date

.....
signature of the expert

2.4 Displacement of the automotive-lift

Displacement of the automotive-lift, expert checking, resumption of work (date, kind of change, signature of the competent)

.....
.....

name, address of the competent

.....
place, date

.....
signature of the competent

2.5 Declaration of Conformity

EG- Konformitätserklärung



gemäß Maschinenrichtlinie Anhang II 1A

Declaration of Conformity according Machinery Directive 2006/42/EG ANNEX II 1A
Déclaration de conformité selon directive machines annexe II 1A
Declaración de conformidad según Directiva Maquinaria 2006/42/EG ANNEX II 1A
Dichiarazione di conformità in accordo alla direttiva 2006/42/EG ANNEX II 1A

Hiermit erklären wir, daß die Hebebühne, Modell:

Hereby we declare that the lift model:

Par la présente nous déclarons que le pont élévateur modèle:

Por la presente declara, que el elevador modelo:

Con la presente si dichiara che il sollevatore:

COMBI LIFT

COMBI LIFT 4.80 H

allen einschlägigen Bestimmungen der folgenden Richtlinien entspricht:

fulfils all the relevant provisions of the following Directives:

correspond aux normes suivantes:

cumple todas las disposiciones pertinentes de las Directivas siguientes:

adempie a tutte le richieste delle seguenti direttive:

Maschinenrichtlinie / Machinery Directive
EMV Richtlinie / EMC Directive

2006/42/EG
2004/108/EG

in Übereinstimmung mit den folgenden harmonisierten Normen gefertigt wurde

was manufactured in conformity with the harmonized norms

fabriqué en conformité selon les normes harmonisées en vigueur.

producido de acuerdo a las siguientes normas armonizadas.

è stato fabbricato in conformità con le norme armonizzate

Fahrzeug- Hebebühnen / Vehicle lifts
Elektromagnetische Verträglichkeit / Electromagnetic compatibility (EMC)

EN 1493: 2010
EN 61000-6-2 , -6-4

Beauftragter für die Technische Dokumentation
Authorised to compile the technical file

Otto Nußbaum GmbH & Co. KG

Seriennummer
Serial number

Seriennummer

Kehl- Bodersweier, 12.03.2012

Hans Nußbaum

3 Technical Information

3.1 Technical ratings

Capacity :	8000 kg
Load distribution	max. 2:1 in or against the drive on direction
Lifting time:	approx. 45 sec. with load
Lowering time	approx. 12 sec. with load
Lifting height:	max. 1800 mm
Line voltage	3 x 400 Volt , 50Hz
Power rating	3 kW (Nr. 990303)
Motor speed:	2800 rotation/min
Pump capacity	4,3 cm ³ /rotation
Hydraulic pressure	approx. 240 bar
Pressure control valve	approx. 260 bar
Oil Tank	approx. 14 Litre
Sound level L _{pA}	≤ 70 dB
Connection by customer	3~/N+PE, 400V, 50 Hz fuse T16A (time-lag fuse) observe your state regulations

3.2 Safety device

1. Safety ratchet
Safety device against unintentional lowering.
2. Holding valve
Safety device against unintentional lowering.
3. Pressure relief valve
Overpressure safety of the hydraulic system
3. Lockable main switch
Safety device against unauthorised operation
4. Safety device at the platform against rolling.
Safety device against falling down, in case the hand brake is not fasten.
5. CE-Stop
Safety device against squeeze.

3.3 Data sheet

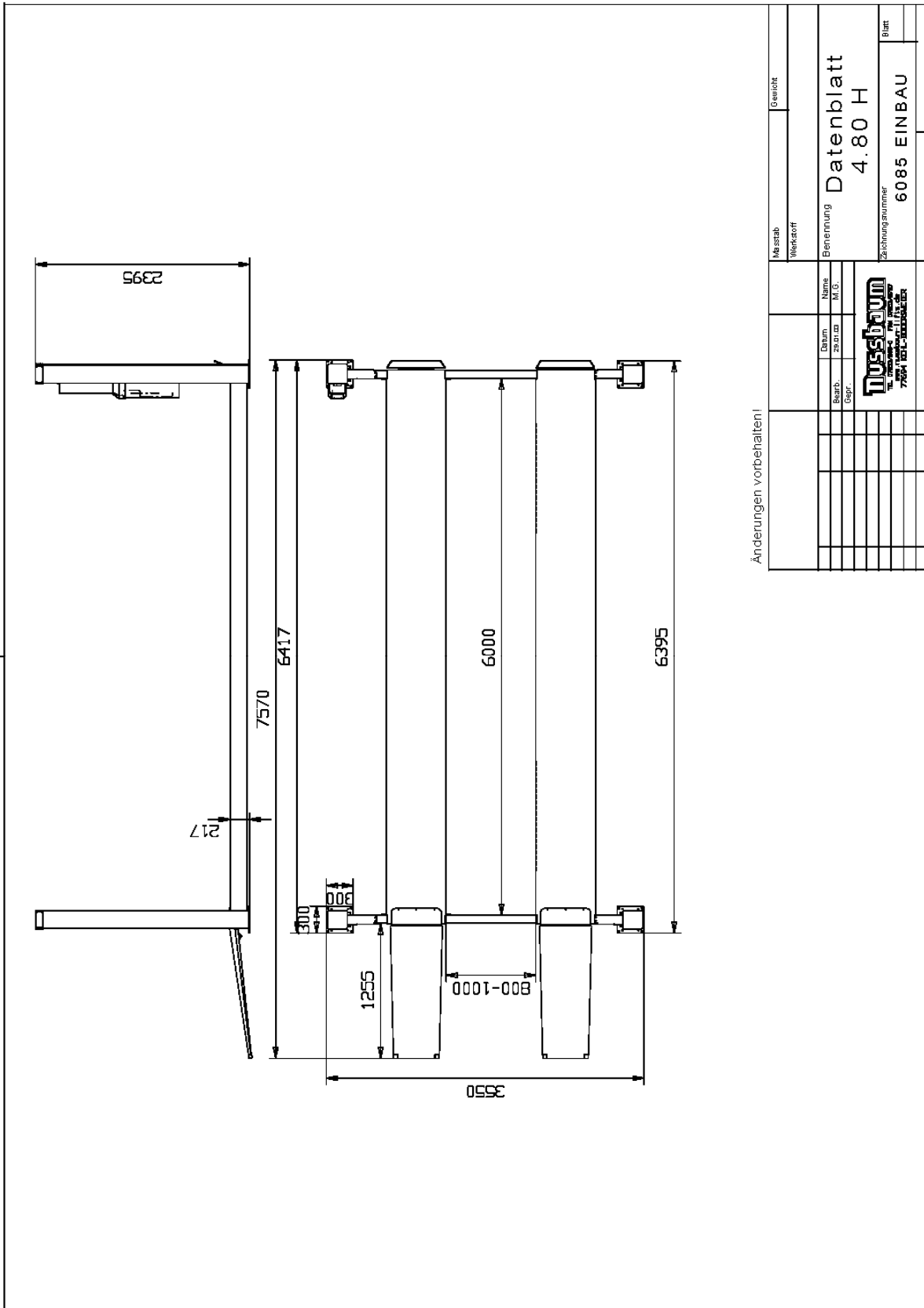

3.4 Foundation diagram drawing

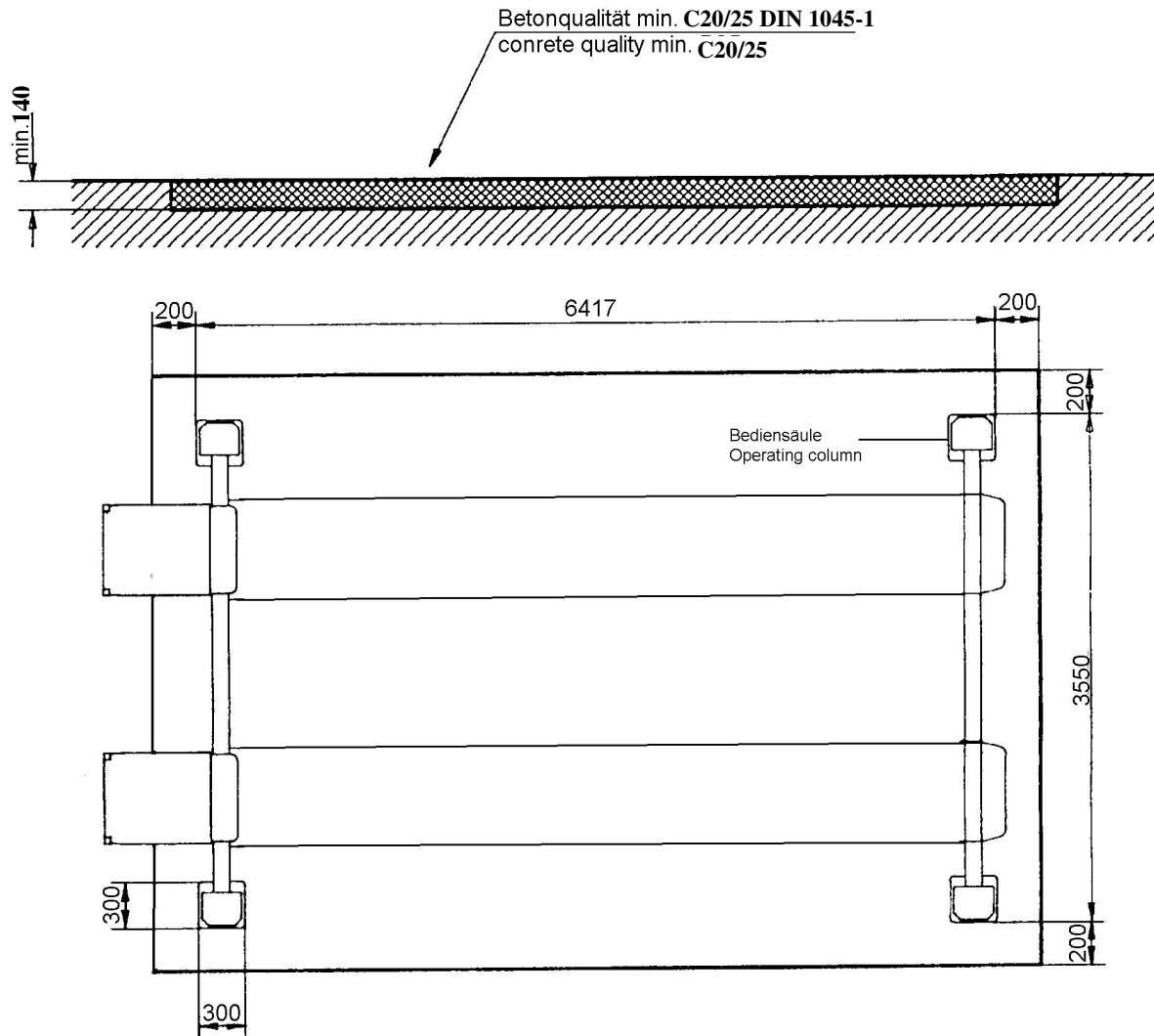

Wir weisen in unseren Plänen auf die Mindestanforderung des Fundamentes hin. Jedoch der Zustand der örtlichen Gegebenheiten obliegt nicht in unserer Verantwortung. Im Bedarfsfall ist ein Architekt/Statiker zu kontaktieren.

We point out the minimum requirement of the foundation in our plans. The condition of the local realities (for example: ground under the foundation) does not lie our responsibility. If necessary an architect must be consulted.

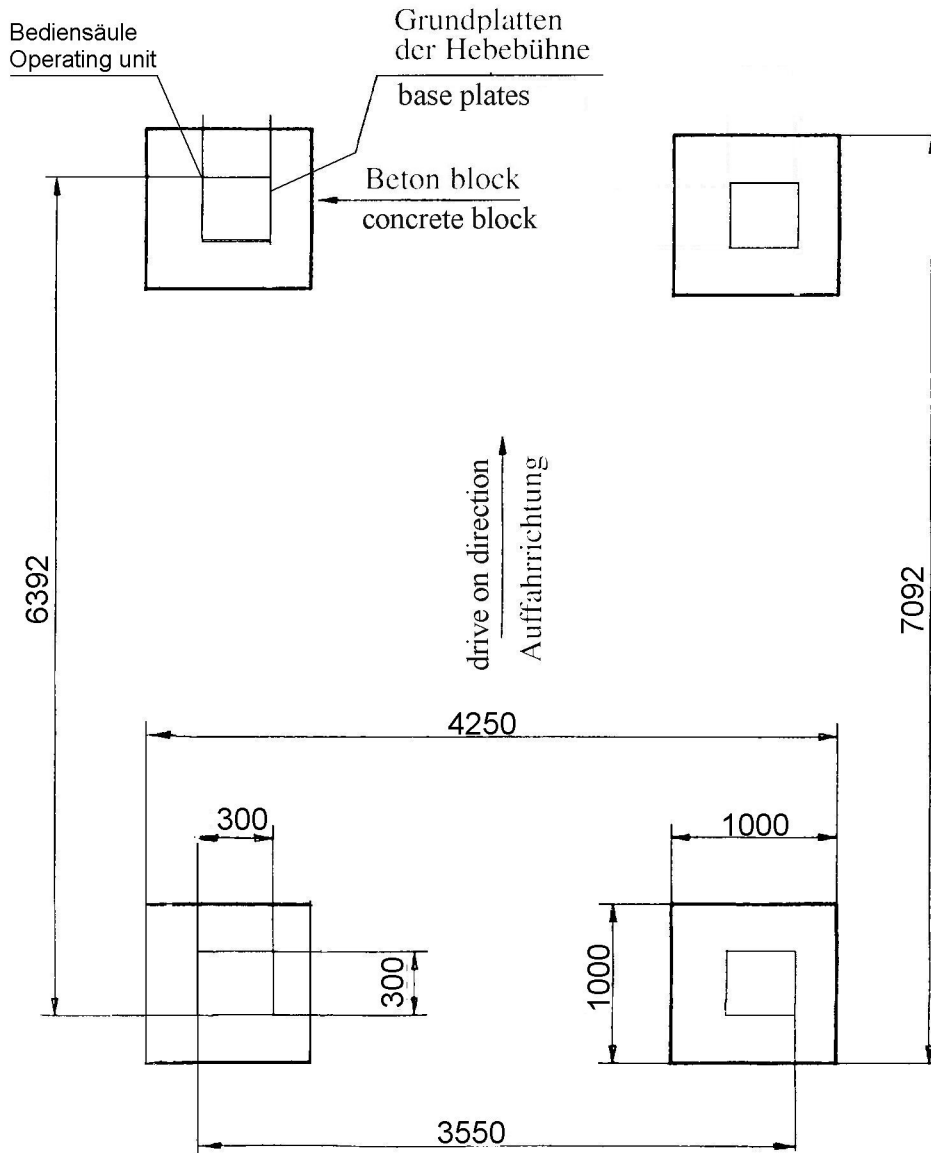
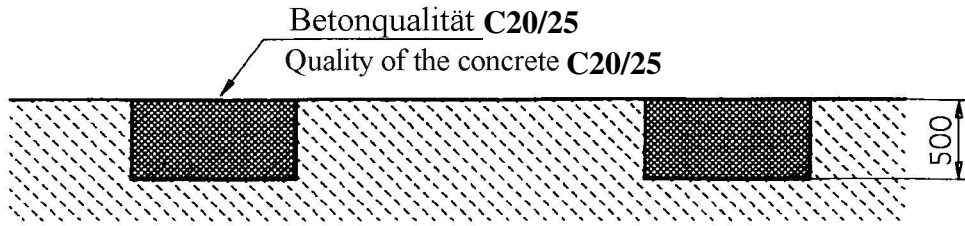

3.5 Hydraulik diagram drawing

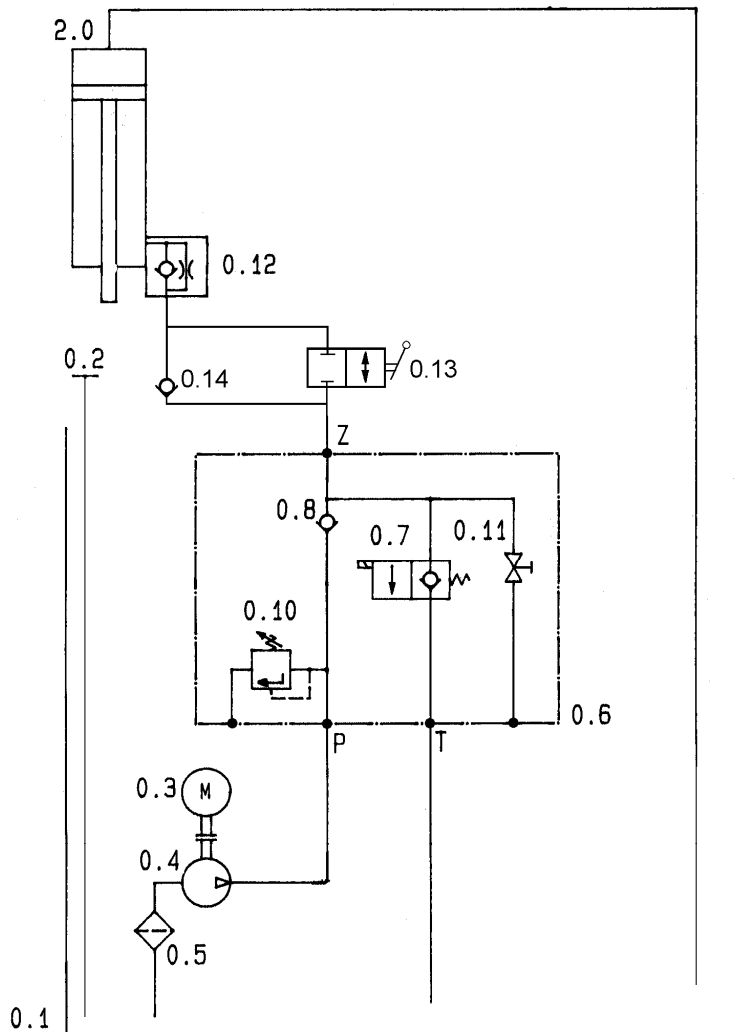

4.45 H 11/02

Hydraulic Parts list

- 0.1 Oil tank
- 0.2 Oil level gauge
- 0.3 Motor
- 0.4 Gear pump
- 0.5 Filter
- 0.6 Hydraulic block complete
- 0.7 Holding valve
- 0.8 Holding valve
- 0.10 pressure control valve
- 0.11 emergency lowering screw
- 0.12 Flow control valve
- 0.13 Ball valve
- 0.14 Holding valve
- 1.0 Cylinder

3.6 Electrical diagram feed in

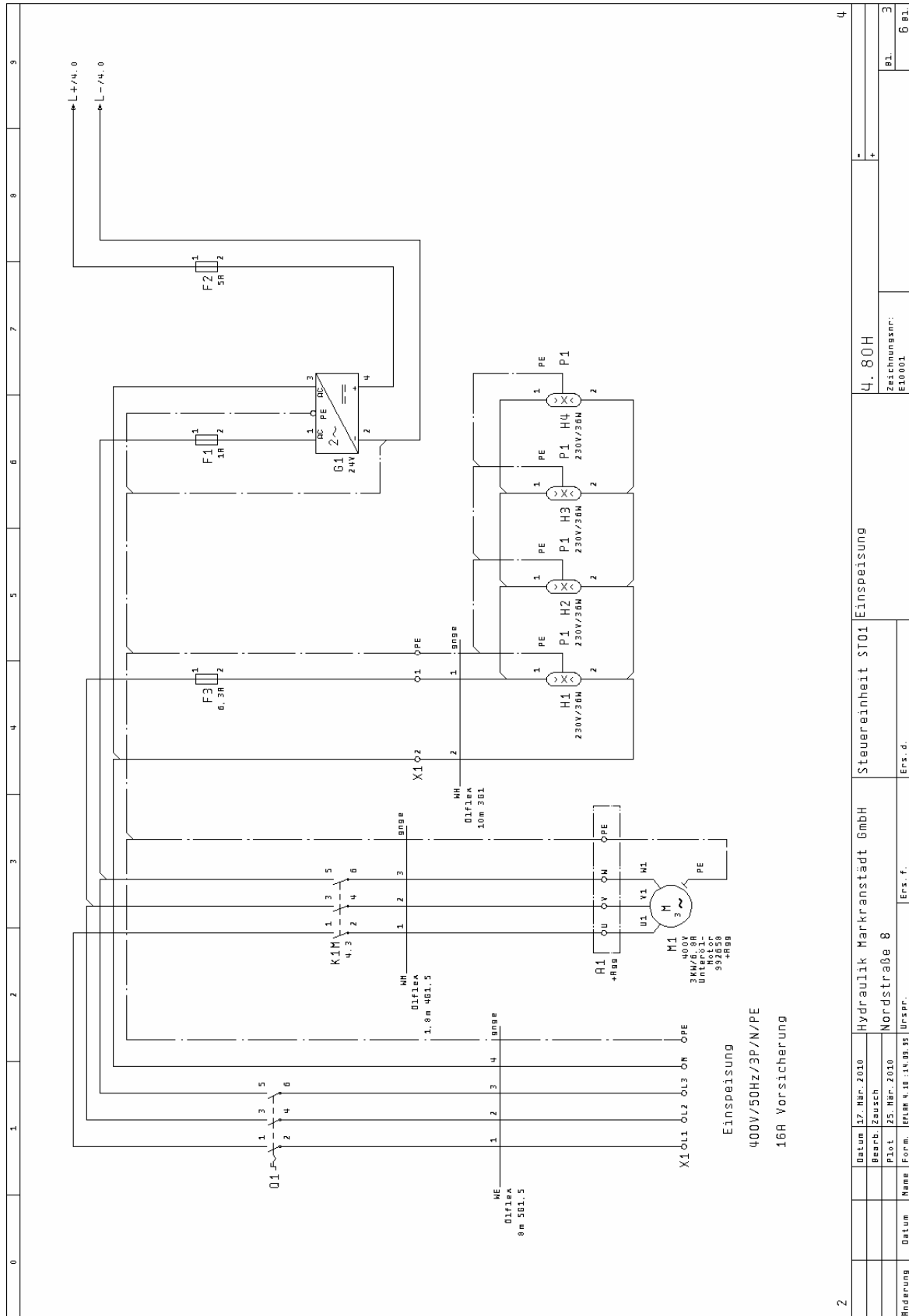

4	4. 80H	Zeichnungsnr.: E10001
Bl.	6 Bl.	
Bl.	3	
Bl.	6 Bl.	

Hydraulik Markranstädt GmbH	Steuereinheit ST01	Einspeisung
17. Mär. 2010	Hydraulik Markranstädt GmbH	Steuereinheit ST01
Bearb. Zausch		
Plot 25. Mär. 2010	Nordstraße 8	
Name Form.	ERUM V.10 (14.03.05)	Urspr.
Datum		Ers. f.
		Ers. d.

3.7 Electrical diagram control system

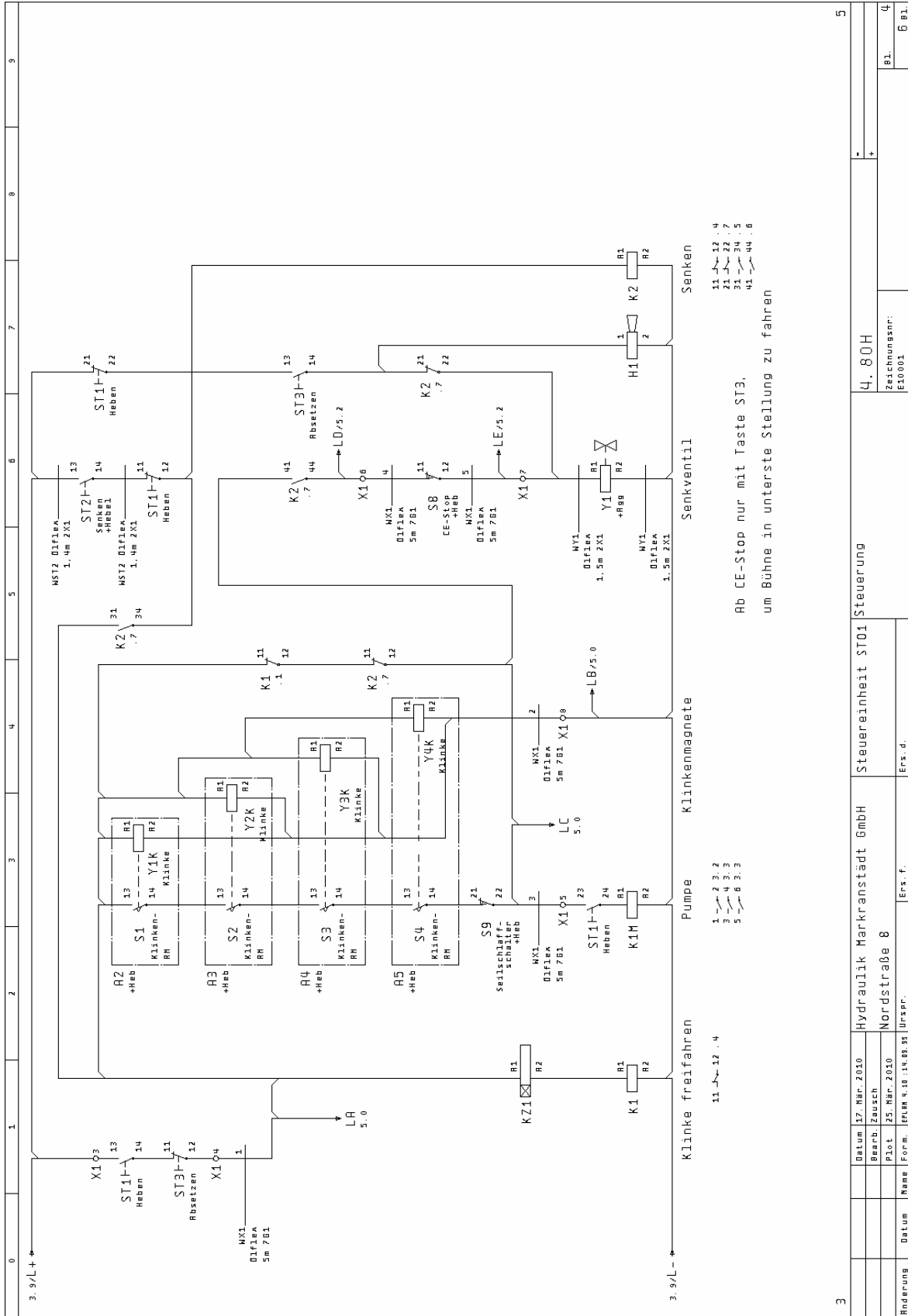

3

5

Änderung	Datum	Name	Form	Urspr.	Ers. f.	Ers. d.	Steereinheit ST01 Steuerung
	17. Mär. 2010						4.80H
	25. Mär. 2010						Zeichnungsnr. E10.001
							B.L.
							6 Bl.

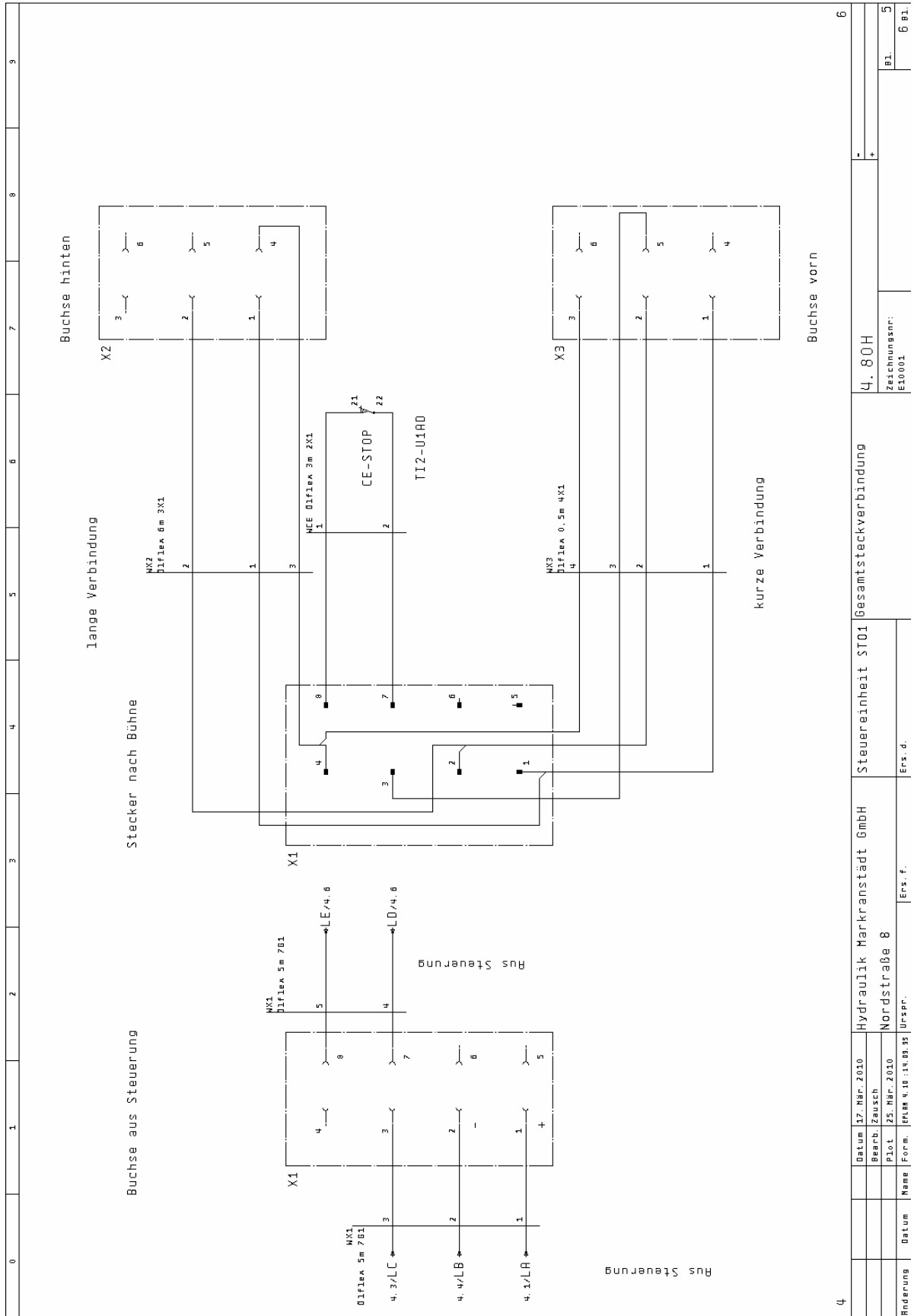

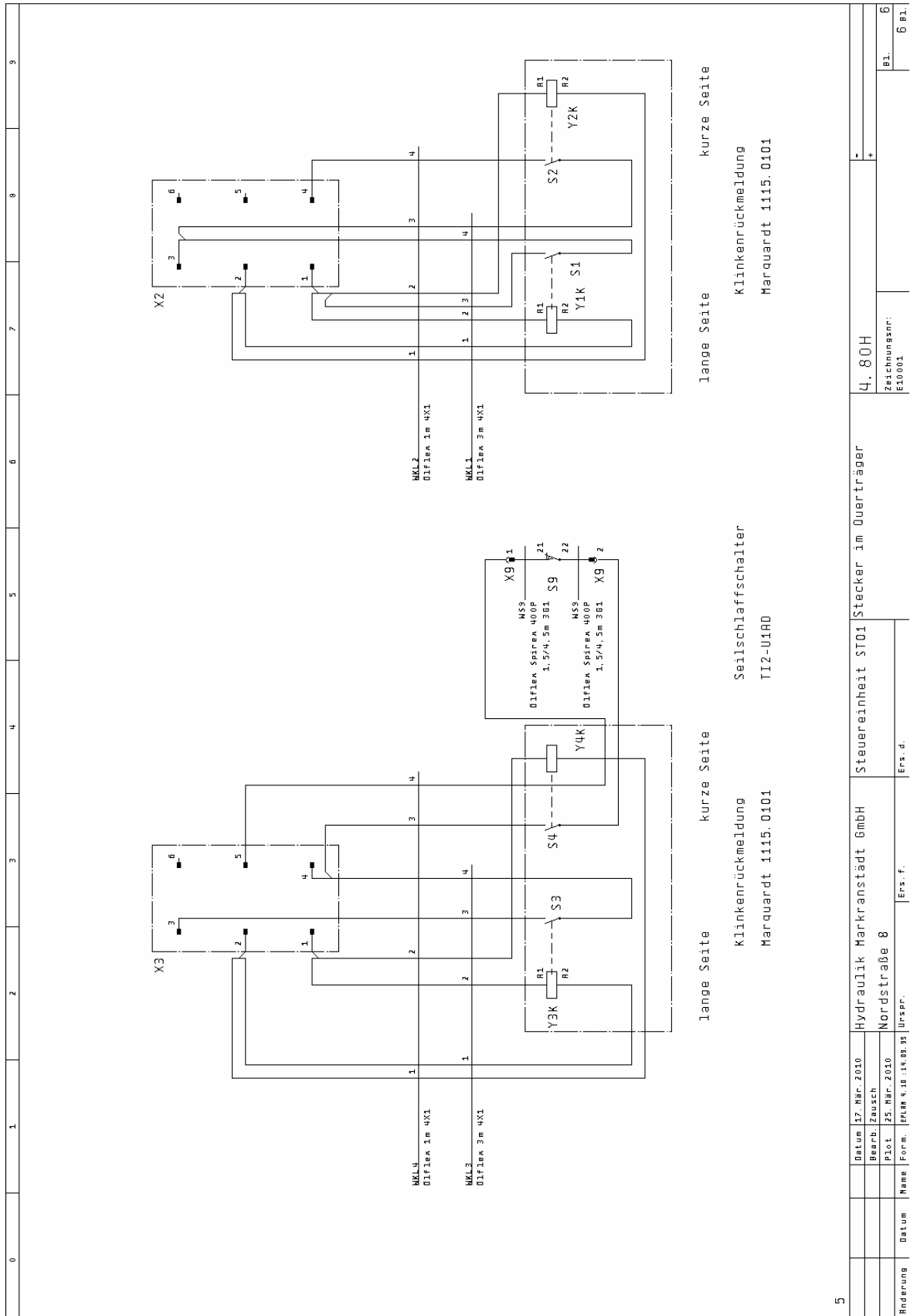

5

Datum		17. Mär. 2010	Hydraulik Markranstädt GmbH	Steuerinheit ST01 Stecker im Querträger	4.80H	-
Bearb.		Zaesch				+
Plot		25. Mär. 2010	Nordstraße 8			
Name		Form.	Form.	Form.		
Datum						
Ers. f.		Ers. d.				
Erspr.		Ursp.				
Bl.		Bl.		Bl.		
6 Bl.		6 Bl.		6 Bl.		

3.8 Connection-command (picture)

Electrical wiring has to be executed qualified personnel only!

Oben-Aus-Schalter / top-off switch

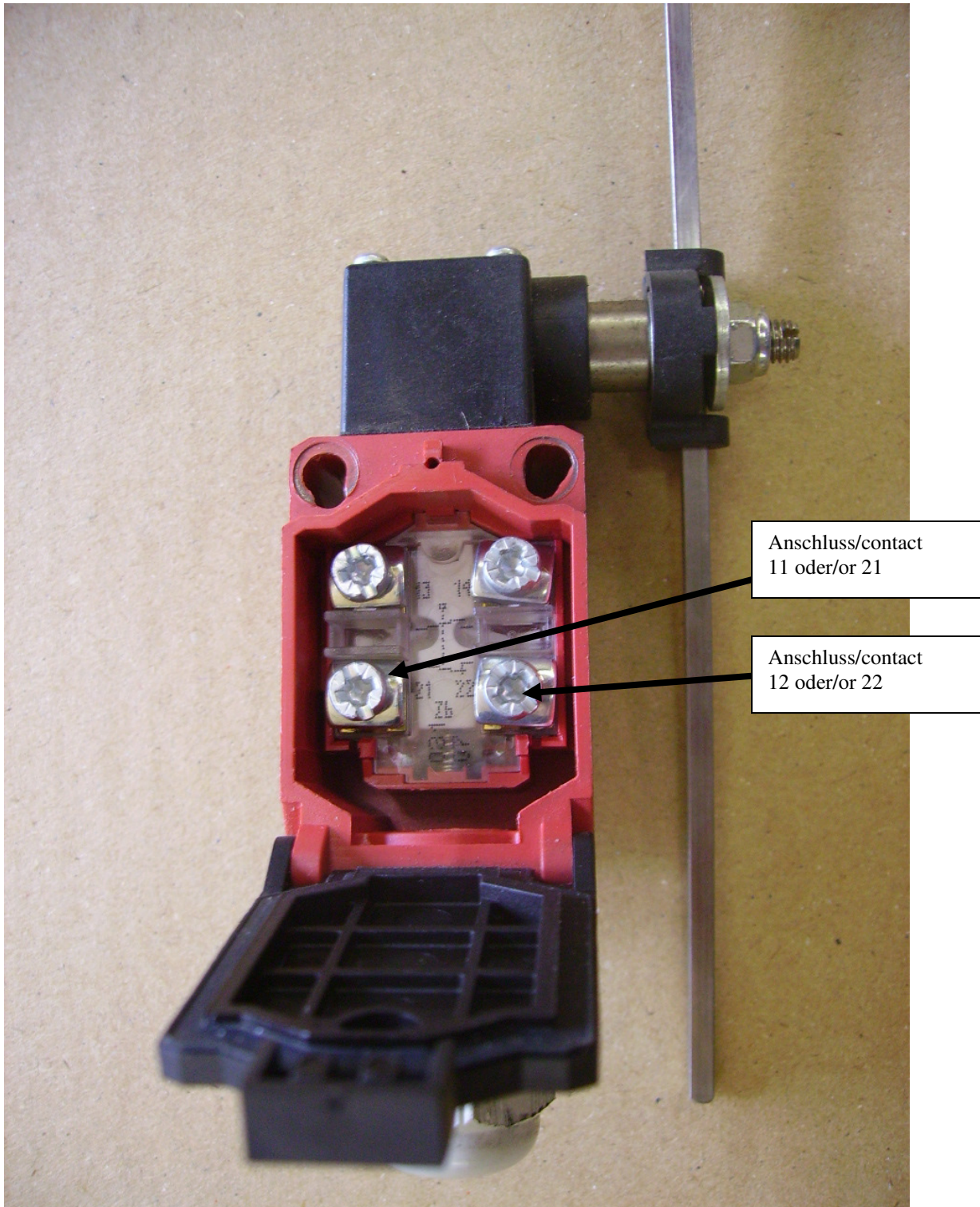

4 Safety regulations

If you use the automotive lift, the German following regulations are to be considered: BGG945: Examine of automotive-lifts; BGR500 Using automotive-lifts; (VBG14).

Especially the following regulations are very important:

- The laden weight of the lifted vehicle must not exceed 8000 kg for the automotive lift. Load distribution max. 2:1 in or against the drive on direction.
- The automotive lift must be in its lowest position (fully collapsed), before the vehicle can be driving on to the lift. Only then can the vehicle be lifted.
- While working with the lift the operating instructions must be followed.
- Vehicles with low clearance or vehicles that are specially equipped should be pre tested to ensure that they clear the lift ramp to avoid damage.
- Only trained personnel over the age of 18 years old are to operate this lift.
- No one is to stand within the working area (danger area) during lifting and lowering
- No one is to be raised or lowed either directly or in a vehicle by the automotive lift.
- No one is to climb onto the automotive lift or onto an already raised vehicle.
- The automotive column lift must be checked by an expert after changes in the construction have been made.
- The main switch must be switched off and locked before work on the vehicle can commence. This is a safety precaution to ensure that the lift does not move during work.
- The main switch must be switched off and locked before any maintenance or repair work on the automotive lift itself can be carried out.
- During lifting or lowering the operator must observe the vehicle to ensure that the vehicle and the lift are functioning correctly.
- Installation of the standard-mobile column lift in hazardous or dangerous locations such as washing bays is dangerous and is not allowed.

5 Operating Instructions



The Safety Regulations must be observed and adhered to while working with the automotive lift. Read the safety regulations in chapter 4 carefully before working with the lift!

5.1 Lifting the vehicle

- Drive the vehicle onto the middle of the lift.



The complete wheels must be standing on the platform, otherwise the vehicle can fall down.

- Secure the vehicle from rolling, put into gear, apply the hand brake.

- Check all the danger points of the lift and ensure that there are no objects or people in the working area around the lift or on the lift.
- Switch on the main switch.
- Raise the vehicle Press the button „Lifting“.
- Raise the vehicle to the required working height. Press the button “lifting“ .
- Observe the complete process.

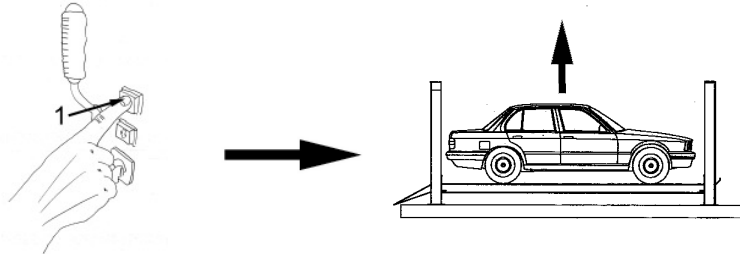

5.2 Lowering the vehicle

- Check all danger points of the lift and be sure that there are no objects or people in the working area (danger area) around the lift or on the lift..
- Press the button at the lever. (unlocking the safety ratchets). After it, pull the lever slowly downward.
The ratchets equipped with a safety switch. It means, only when all four ratchets are free, the lift will lower.
- The lowering process begins directly.
- In case the lift is in the safety ratchets, raise the lift a few millimetres. Press the button “lifting” and repeat the lowering process.
- Lower the lift to the required working height or to its lowest (or fully collapsed) position. Observe the complete lowering process.
- Before the lift reaches its lowest position, the lift stops automatically (CE-Stop). After the lift has stopped, check the danger areas around the lift. Press the button “lowering” again. A warning signal will sound as the lift is further lowered. This is to warn against the risk of crushing as the lift is lowered to its lowest (fully collapsed) position.
- Drive the vehicle off the lift if it is in the lowest position.

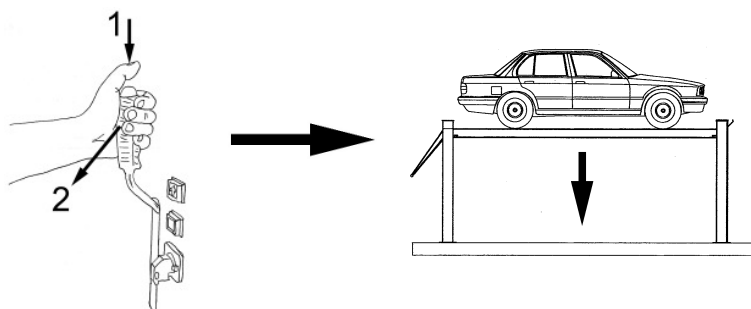

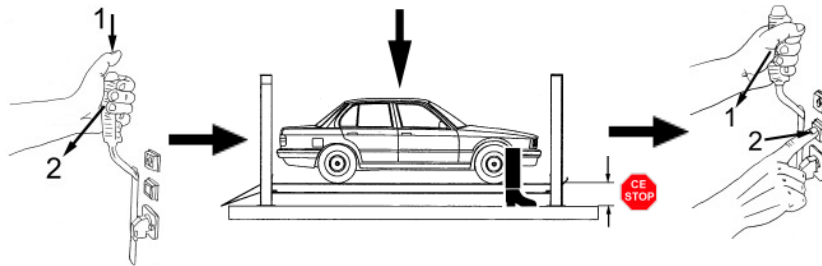

CE-STOP

5.3 Lower the lift into the safety ratchets

- Press the button „lowering“ and the pull the lever slowly. The lowering process begins directly.
- Press the button „lifting“ to raise the lift out of the ratchets.

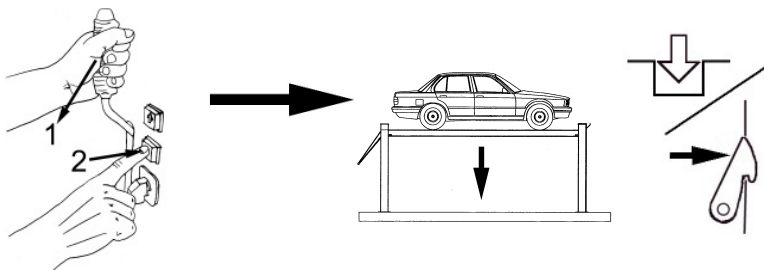

5.4 Adjusting the platform

- It is possible to adjust the rail of the different wheelbase. That is necessary to reach the different wheelbases of the vehicles. One platform is only movable without load. The measure 850-1150 mm between the platform can be reached.
- Remove the load and raise the lift on approx. 1000 mm height. The platform is movable on the chosen position without high force.

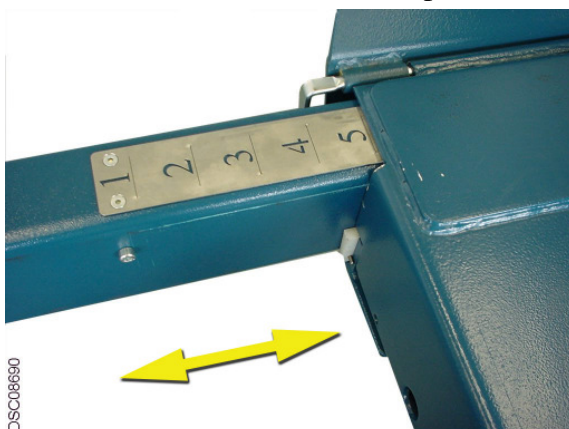

adjustable platform

D5C08650

6 Troubleshooting

If the lift does not work properly, the reason might be quite simple. Please check the lift for the potential reasons mentioned on the following pages. If the cause of trouble still cannot be found, please call technical service.

Self-employer repair-working is prohibited.

Problem: Motor does not start!	
Potential causes: <i>No power supply</i> <i>Main switch is not engaged</i> <i>The main switch is defective</i> <i>The main fuse defective</i> <i>The feed line is cut</i> <i>Thermal switch in the motor is active</i> <i>Motor is defective</i>	solution: <i>Check the power supply</i> <i>Check the main switch</i> <i>Check the main switch</i> <i>Check Fuse</i> <i>Check the complete cable</i> <i>Let motor cool down</i> <i>Call technical service</i>

Problem: Motor starts, lift does not lift!	
Potential causes: <i>The vehicle is too heavy</i> <i>Level of the oil is too low</i> <i>The ball valve is defective</i> <i>Hydraulic valve is defective</i> <i>Gear pump is defective</i>	solution: <i>unload the vehicle</i> <i>check the oil level, fill with hydraulic oil as required</i> <i>Call technical service</i> <i>Call technical service</i> <i>Call technical service</i>

Problem: the lift does not lower!	
Potential causes: <i>An obstacle is restricting the lift from being lowered</i> <i>The ball is defective</i> <i>Fuse is defective</i> <i>The ratchets are locked or defective</i> <i>Button "unlocking the ratchets" is defective</i> <i>Wrong sequence when operation</i> <i>No feedback from the ratchet switch</i>	solution: <i>(see chapter 6.1)</i> <i>Call technical service</i> <i>Check the fuse</i> <i>Call technical service</i> <i>Call technical service</i> <i>See chapter 5.2</i> <i>Call technical service</i>

6.1 Lowering onto an obstacle

- In case the lift is lowering onto an obstacle, only the ropes are slack which are in the near area of the obstacle.
The ratchet is pressed by the mechanical spring-pressure to the front and interrupts the contact to the Micro switch.
- The automotive-lift turns-off, and the lowering process stops.
- In case the ropes are slack, press only the button “lifting” and raise the lift until the obstacle can be removed.

6.2 Emergency lowering

It is possible to open the hydraulic valve manually to lower the lift into the lowest position.



A emergency lowering is an intervention into the controls of the lift and can be done only by experienced expert.

The emergency lowering must be carried in this order. Otherwise a malfunction may lead to damage to equipment, injury or even death.



Every kind of external leakage must be removed. This is particularly necessary before an emergency lowering.

The emergency lowering may only be done by persons who are trained in using the lift.

- Loosen and remove the cover of the safety ratchet at the crossbeam.
- In case the lift is locked in the safety ratchets, every ratchet must pull back manually.
First, raise the crossbeam with a help of a jack until the tooth of the ratchet is movable.
Fasten the ratchet with suitable support (wire), so the ratchet tooth of the ratchet can not engage in ratchet-strip any more.
Repeat this process at all four ratchets.
- Check all danger points of the lift and be sure that there are no objects or people in the working area (danger area) around the lift or on the lift..
- Loosen security nut of emergency lowering screw at operating unit (marked with red colour, see picture).

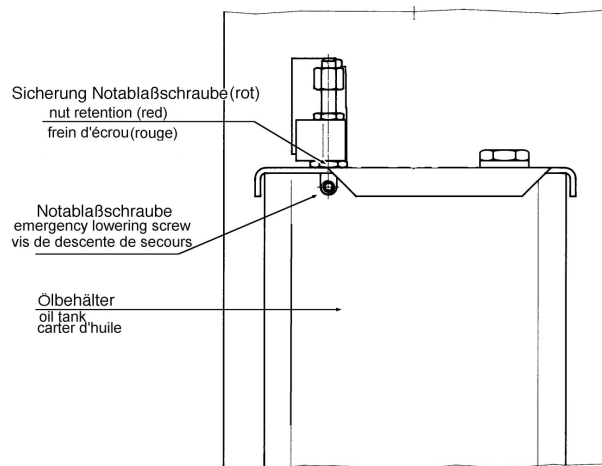

- Loosen emergency lowering screw (thread pin) for about one turn (unscrew it).
- Pull the lever slowly downwards. The emergency-lowering starts directly.
- Observe the complete lowering process. In case of danger, let go off the lever.
- Lower the lift into the lowest position.
- Remove the vehicle if the lift is in the lowest position.
- Fasten set screw and secure it by fastening the security screw of the hydraulic unit.
- Switch off the main switch and secure it against unauthorised operation until the defective pieces or valves have been replaced.
Call your service partner.
- If the lift has been deemed safe to operate, carry out a reset as described in the operating instructions.



Do not work with the lift until the defective parts are changed.



After the emergency-lowering process, remove the wire at the ratchets; otherwise the safety device is out of function.

7 Inspection and Maintenance



Before conducting maintenance work, preparations must be made to ensure that during maintenance and repair work there is no risk to the safety of people working on or around the lift and also that there is no risk of damage to equipment being used on or around the lift.

To guarantee the utmost availability and to ensure that the lift remains functional, maintenance work contracts are organised between our clients and their local retailers. A service must be performed at regular intervals of 3 months through the operator in accordance with following service manual. If the lift is in continuous operation or in a dirty environment, the maintenance rate must be increased.

During daily operation the lift must be closely observed to ensure that it is functioning correctly. In the case of malfunction or leakage the technical service must be informed.

7.1 Maintenance plan of the lift

- Before beginning any maintenance work isolate the power supply. Secure the main switch (lock it). Secure the danger area around the automotive lift and secure the lift against unintentional lowering.
- Clean and check the stripper of the cylinder.
- Clean the piston-rod using compressed air..
- Clean the protection hose at the operating column. Grease it with a multipurpose liquid, otherwise the hose sticks to the column.
- Check the condition of ropes. If torn wires are discovered, the complete rope-set must be changed.
- Check the condition of the electrical parts.
- Clean and lubricate the moving parts of the lift (hinge bolts, sliding pieces, sliding surfaces) grease with a multipurpose liquid (example: Auto Top 2000 LTD. Agip).
- Grease the lubricate nipples with a multipurpose lipid. (example: Auto Top 2000 LTD. Agip).
- Clean and check the function of the ratchet. Grease the surface with a multipurpose lipid.
- Check all welded joints for cracks on the automotive-lift.
If any cracks are found on the lift cease use immediately. Switch-off and secure the main switch (lock) and call the service partner.
- Check all surfaces and repair if necessary.
- Damage to external surfaces, must be immediately repaired.
If theses repairs are not made immediately, permanent damage to the powder-coated surface may result.
Repair and clean damaged areas with an abrasive paper (grain 120). After this is complete, use a suitable paint (observe the RAL Number).
- Check the zinc surface and repair it with a suitable tool. Use abrasive paper (grain 280).
White rust can result from moisture laying in certain areas for long periods of time. Poor aerating can also result in rust formation.
Rust may result from mechanical damage, wear, aggressive sediments (de-icing salt, liquids) or insufficient cleaning.
Repair and clean these areas with abrasive paper (grain 280).
After this is complete, use a suitable paint (observe the RAL Number).
- The hydraulic oil has to be changed at least once a year. To change the oil, lower the lift into its lowest position. Empty all tanks and refill with clean oil, approx. (see chapter 3.) per hydraulic unit are needed.

Use an ATF-Suffix hydraulic-oil (OEST Company) if the ambient temperature is under 5 degrees centigrade. After filling, the hydraulic oil must be between the upper and lower markings of the oil level gauge.

Remove the old oil according to the appropriate regulations.

- Check the hydraulic tubes for leakage.
- It is prescribed (VBG 14, § 52-3 German regulation) to exchange the hydraulic hose if its necessary, but latest after 6 years.
- Check that all screws and bolts are correctly torque (turning moments, see the list)

Turning moment for screws

property class 8.8

	0,10*	0,15**	0,20***
M8	20	25	30
M10	40	50	60
M12	69	87	105
M16	170	220	260
M20	340	430	520
M24	590	740	890

property class 10.9

	0,10*	0,15**	0,20***
M8	30	37	44
M10	59	73	87
M12	100	125	151
M16	250	315	380
M20	490	615	740
M24	840	1050	1250

Drehmomenttabelle 8.8-10.9 E

- * sliding friction 0,10 for very good surfaces, lubricated
- ** sliding friction 0,15 for good surfaces, lubricated oder dry
- *** sliding friction 0,20 surface black or phosphatized, dry

7.3 How often must the lift be cleaned?

A regular and appropriate maintenance practice will aid the preservation of the lift.

No guarantees can be given when damage (egg rust or fading colour) is the direct result of poor maintenance and cleaning practice.

Regular cleaning of all kinds of dirt is the best protection against wear and the formation of rust and will prolong the life of the lift

- Dirty deposits that can cause rust include:

- de-icing salt
- sand, pebble stone, natural soil
- all types of industrial dust
- water; also in connection with other environmental influences
- all types of aggressive deposits
- constant humidity caused by insufficient ventilation

Obviously this is dependent on the type of work being done with the lift, the degree of cleanliness of the workshop and location of the lift. The degree and amount of dirt is dependent on the season, on the weather conditions and the ventilation of the workshop. During poor conditions it may be necessary to clean the lift once week, but cleaning once a month will suffice.

Clean the lift and the floor with a non-aggressive and non-abrasive detergent. Use a gentle detergent to clean the parts. Use a standard washing-up liquid and lukewarm water.

- Do not use steam jet cleaners.
- Remove all dirt carefully with a sponge or if necessary with a brush.
- Ensure that no washing-up liquid is left on the lift after cleaning.
- Do not use aggressive means for cleaning the workshop floor and the automotive lift.
- A permanent contact with any kind of liquid is not allowed. Do not use high pressure devices for cleaning the lift.

8 Security check

The security check is necessary to guarantee the safety of the lift during use. It has to be performed in the following cases:

1. Before the initial operation, after the first installation.
Use the form “First security check before initiation”
2. In regular intervals after the initial operation, at least annually.
Use the form “Regular security check at least annually”
3. Every time the construction of that particular lift has been changed.
Use the form “Extraordinary security check”



The first and the regular security check must be performed by a competent person. It is also recommended to carry out a service on the lift at this time.



After the construction of the lift has been changed (changing the lifting height or capacity for example) and after serious maintenance works (welding load bearing parts) an extraordinary security check must be performed by an expert.

This manual contains forms with a schedule for the security checks. Please use the appropriate forms for the security checks. The forms should remain in this manual after they have been filled out. A short description about special safety devices follows.

9 Handing over and Initiation

9.1 Regulations

- The installation of the lift is performed by trained technicians of the manufacturer or one of its distribution partners. If the operator can provide trained mechanics, he or she can install the lift by him or herself. The installation has to be done according to this regulation.
- Installing the standard-automotive lift in a hazardous location or a washing bay is not allowed..
- Before installation a sufficient foundation must be constructed. If the foundation is already constructed then proof that the foundation conforms to the standard is required.
A level foundation for the installation is required. The foundations must be based in a frost resistance depth, both outdoors and indoors in a position where the installer believes there is no chance of frost.
- An electrical supply 3~/N+PE, 400 V, 50 Hz must be provided.
The supply line must be protected with a time-lag fuse T16A (VDE0100 German regulation). The minimum diameter amounts to 2.5 mm².
- All cable ducts must be equipped with protective coverings to prevent accidents.

9.2 Erection and bolting down the lift

It is necessary to dowel the columns at 4 points. For this a concrete floor without reinforcement, thickness of 140 mm and quality C20/25 is needed. In case of doubt a test drill is necessary and a dowel is to put in. Afterwards the Liebig-dowel (German Dowel manufacturer) is to fasten with a torque of 40 Nm. If the necessary torque is too low or if there are cracks in the concrete floor, a foundation in accordance with the sheet "foundation plan" is to erected. As well it must be paid attention that the installation place is even to guarantee a horizontal erection of the lift.

- Put runways on two erection trestles at installation place, pay attention of exactly difference between the runways (refer to data sheet)
- Position the Traverses on the face of the runways, and put the plugs together.
- Lay out Ropes into right position (see pic)
- Fasten the crossbeam at the rail. Connect the plugs (optional: lighting, CE-Stop switch).
- Pull the ropes through the crossbeam.
- Pull cables (power supply, air etc.) through the crossbeam and connect..
- Position the columns at the end of the crossbeam.
- Adjust the columns with a water bubble.
- Bore holes to fix the dowels through the borings of the base plates. Clean holes with pressure air. Put in safety dowels with washers in borings. The manufacturer demands LIEBIG safety dowels type B 10 or equal dowels of another manufacturer

(with allowance) but observe their regulations! Before doweling check concrete floor with quality C20/25 if the concrete floor goes to the top edge of the floor. In this

case the dowels have to be chosen according to picture 9. If the ground is covered with floor tiles, the dowels have to be chosen according to picture 10.

- Tighten the dowels a little bit.
- Fasten the ropes at the top of the column.
- Check the position of the columns again.
- Connect the electrical power supply.
- Fasten the crossbeam at the rail one more time.
- Fill in the hydraulic oil. (Litre ? see chapter 3.)



In case of operation the automotive-lift, the chapter " Safety regulations" and "Operating instruction" must be observed.

- Raise the lift until the supports can be removed. Press the button "lifting"
- Remove the supports.
- Lower the lift into the lowest position. (See chapter 5.2). Fasten the ratchet-strip.
- Raise the lift and hang the spring into ratchet strip.



pic 6: Hang the spring into the ratchet-strip

- Lower the lift into the ratchet. (press the button „lowering“ and pull the lever downwards).
- Adjust the columns again with a water bubble.
- Fasten the dowels with a torque key.
- Fasten the ramps and the safety device at the end of the rail.
- Adjust the sliding guidance at the crossbeam (approx. 4-5 mm movement between the sliding guidance and the column).
- Adjust regular height of the rails at all of the four columns by moving the nuts, which fix the carrying ropes in the head plate. For demanded measuring accuracy of all important vehicle manufacturer it is necessary to install the lift very exactly and to line it up. For this to the following points should be paid attention.

- Lift the automotive lift to eye level and lower it down in the ratchet (refer to operating instructions).

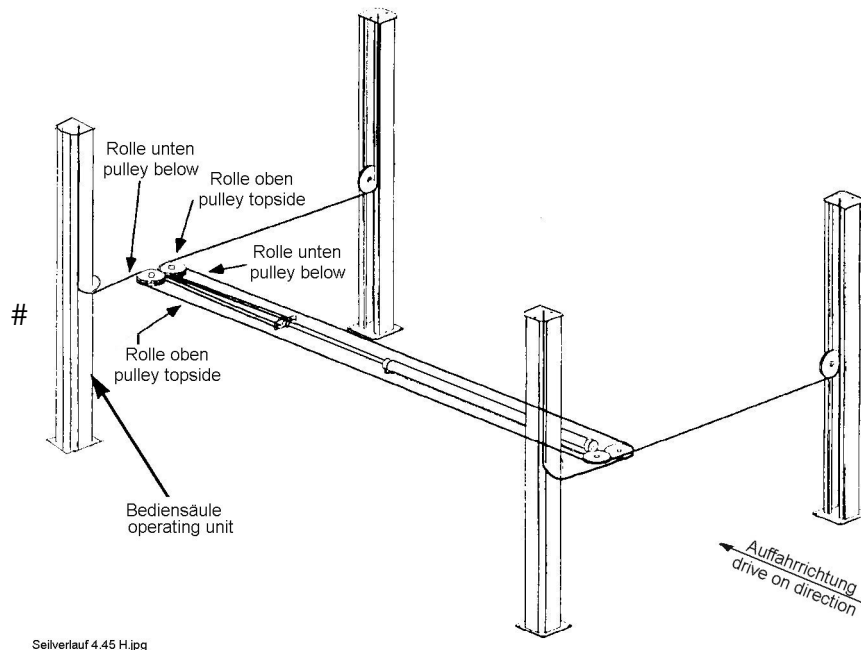

Clean the protection hose at the operating column after the building. Grease it with a multipurpose liquid before the first lifting and lowering process, otherwise the hose sticks to the column.

9.3 Change of lift location

If the place of installation is to be changed, the new place has to be prepared in accordance to the regulations of the first installation. The change should be performed in accordance with the following points:

- Remove the spring at the ratchet-strip.
- Lower the lift in the lowest position
- Loosen and remove the ratchet-strip. If necessary, pull back the ratchet manually.
- Remove the cover of the Oil tank and remove the oil.
- Raise the lift on a working height. Press the button „lifting“
- Lower the lift until the rails are lay on the erection trestles.
- Disconnect the power supply.

- Disconnect the hydraulic hoses.
- Loosen and remove the dowels.
- Loosen and remove the screws of the crossbeam.
- Transport the automotive-lift to the its new location
- Install the lift in accordance with chapter 9 “ Installation and Initiation”.



Use new masonry-bolts, the used bolts can not be used again.



A security check must be performed before reinitiating by a competent person. Use form “Regular security check”

9.4 Initiation



Before the initiation a security check must be carried out. Therefore use the form: First security check.

If the lift is installed by a competent person, he or she is to perform the security check. If the operator installs the lift by him or herself, he or she must instruct a competent person to perform the security check.

The competent confirms the faultless function of the lift in the installation record and the form for the security check and authorises the use of the lift.



Please send the completed installation record to the manufacturer after installation.

Pic 9: choice of the dowel length without floor pavement or tile surface
BM10-15

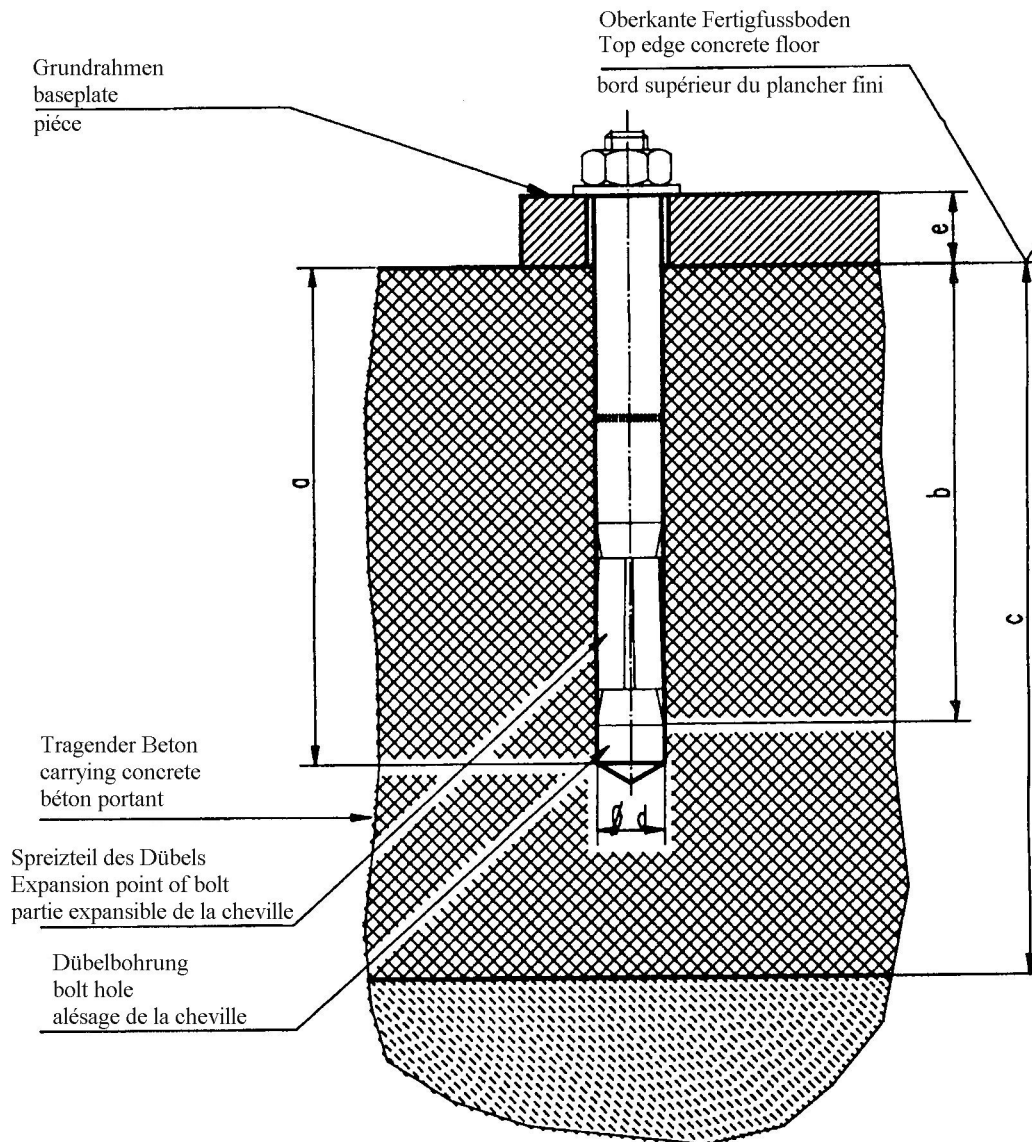

Liebig-dowels	
Dowel type	BM10-/70/40
Drilling depth	a 85
Min. anchorage depth	b 70
Thickness of concrete	c min.140(*)
Diameter of bore	d 15
Thickness of the lift-pieces	e 0-40
Number of dowels	X
Starting torque	40

(*) minimum thickness of concrete by using the mentioned dowels. Otherwise, observe the regulation of the foundation plan.

You can use equivalent dowels from another dowel manufacturer (with license) but observe their regulation.

Pic 10: choice of the dowel length with floor pavement or tile surface

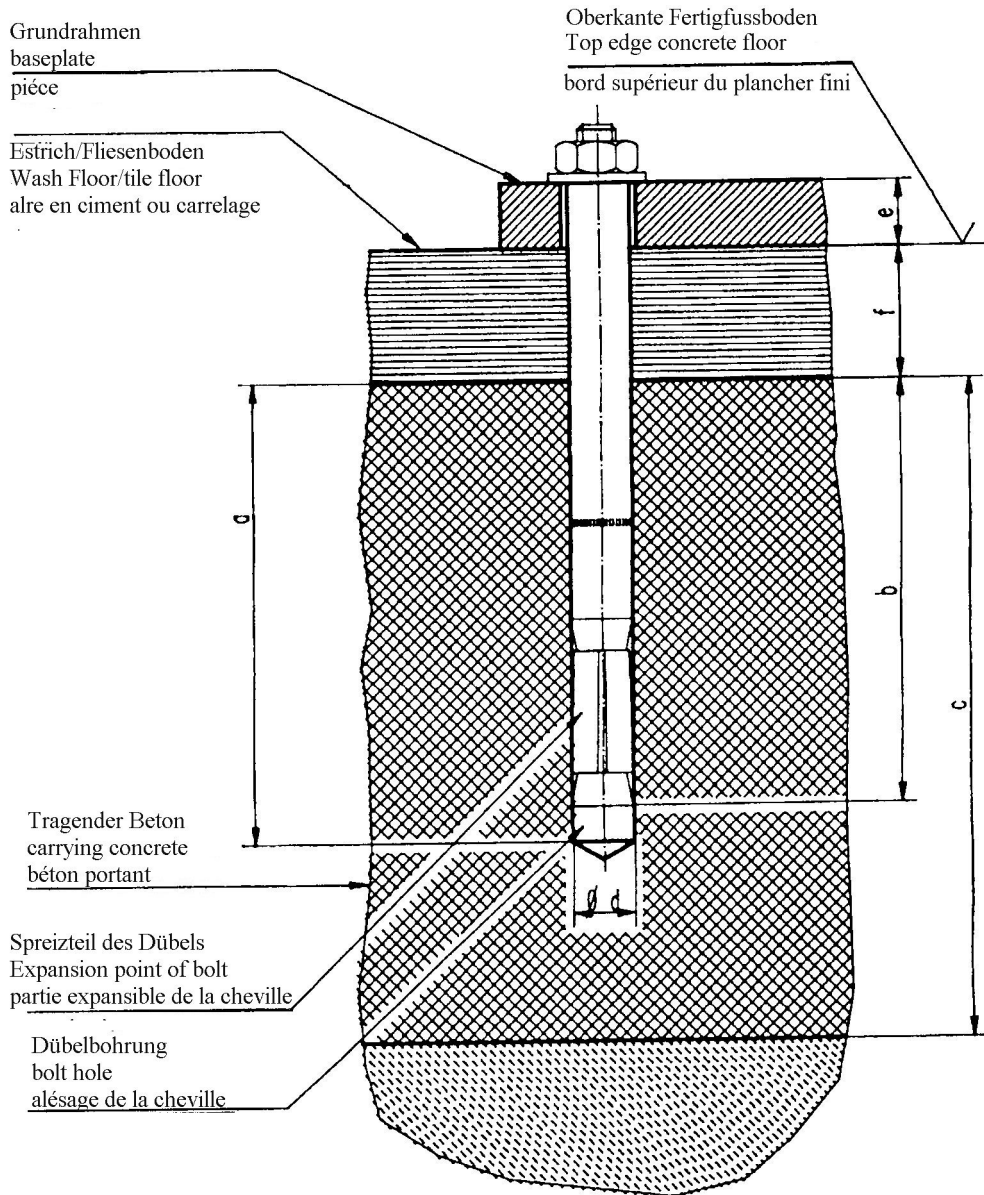

Liebig-dowels

Dowel type		BM10-15/70/65	BM10-15/0/100	BM10-15/70/140
Drilling depth	a	85	85	85
Min. anchorage depth	b	70	70	70
Thickness of concrete	c	min.140(*)	min.140(*)	min.140(*)
Diameter of bore	d	15	15	15
Thickness of the lift-pieces	e	40-65	65-100	100-140
Number of dowels		x	x	x
Starting torque		40 Nm	40Nm	40Nm

(*) minimum thickness of concrete by using the mentioned dowels. Otherwise, observe the regulation of the foundation plan.

You can use equivalent dowels from another dowel manufacturer (with license) but observe their regulation.

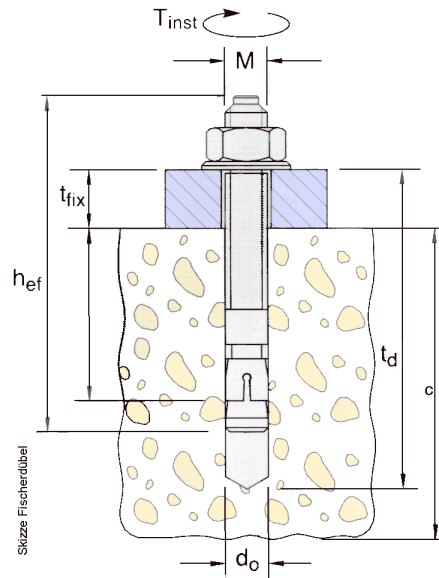

Änderungen vorbehalten!
subject to alterations!
sous réserve des modifications!

fischer-Dübel		Jumbo ^b , Sprinter ^b , 4.32H ^c -4.300H ^c , 1.25 SH-1.35SH ^a , 2.30 TLS ^a , 2.35 TS/TSA/TSK ^a , 2.32TSAP ^a , 2.35TSAPH ^a ,	2.25SL ³ , 2.32SL ^o -2.35 SL ^o , SPL ^b /Power-Lift ^b , 1.20 SE ^b UNI-LIFT 3500 NT/CLT ^d , 2.32TTL ^a	HDL5000 ^e , HDL6500 ^e , 250SE ^f ,
Dübel typ of dowel type de cheville		FH 15/50 B	FH 18 x 100/100 B	FH 24/100 B
Bohrteife drilling depth Profondeur de l'álezage	t _d	145	230	255
Mindestverankerungstiefe min.anchorage depth Profondeur minimale d'ancrage	h _{ef}	70	100	125
Betonstärke thickness of concrete Epaisseur du béton	c	siehe den aktuellen Fundamentplan see current foundation-diagram drawing vois le plan de fondation actuel		
Bohrerdurchmesser diameter of bore Diamètre de l'álezage	d _o	15	18	24
Bauteildicke thickness of the lift-piece Epaisseur de la pièce	t _{fix}	0-50	0-100	0-100
Anzugsdrehmoment Nm turning moment moment d'une force	M _D	40	80	120
Stückzahl pièce number nombre des pièces	a	4		
	b	8		
	c	10		
	d	12		
	e	16		
	f	20		

Montage

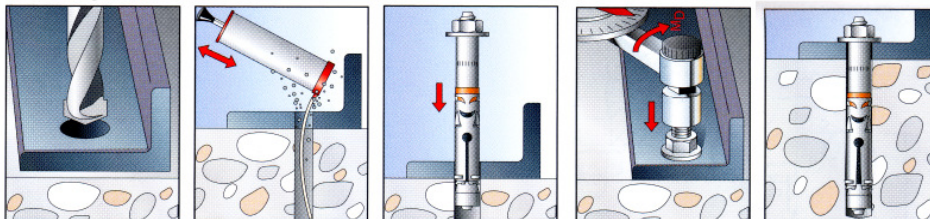

Es können auch gleichwertige Sicherheitsdübel anderer Hersteller (mit Zulassung) unter Beachtung deren Bestimmungen verwendet werden.
It is possible to use equivalent safety-dowels (with license) of other manufacturer but observe their regulations.
Des chevilles des autres marques (autorisées) peuvent aussi être choisies en respectant les directives du fabricant.

First security check before installation

Serial-no.: _____



Filling out and leave in this manual

kind of check	all right	defect missing	verification	remark
Type plate.....	<input type="checkbox"/>	<input type="checkbox"/>	<input type="checkbox"/>
Short operating instruction.....	<input type="checkbox"/>	<input type="checkbox"/>	<input type="checkbox"/>
Warning designation.....	<input type="checkbox"/>	<input type="checkbox"/>	<input type="checkbox"/>
Sticker max. capacity.....	<input type="checkbox"/>	<input type="checkbox"/>	<input type="checkbox"/>
Designation lifting/lowering.....	<input type="checkbox"/>	<input type="checkbox"/>	<input type="checkbox"/>
Detailed operating instruction.....	<input type="checkbox"/>	<input type="checkbox"/>	<input type="checkbox"/>
Lockable main switch.....	<input type="checkbox"/>	<input type="checkbox"/>	<input type="checkbox"/>
Condition, Function Button „Lifting“.....	<input type="checkbox"/>	<input type="checkbox"/>	<input type="checkbox"/>
Condition, Function Lever „Lowering „.....	<input type="checkbox"/>	<input type="checkbox"/>	<input type="checkbox"/>
Function Button „unlocking ratchet“.....	<input type="checkbox"/>	<input type="checkbox"/>	<input type="checkbox"/>
Function „Lowering into the ratchet“.....	<input type="checkbox"/>	<input type="checkbox"/>	<input type="checkbox"/>
Condition „roll over safety device“.....	<input type="checkbox"/>	<input type="checkbox"/>	<input type="checkbox"/>
Condition Cover.....	<input type="checkbox"/>	<input type="checkbox"/>	<input type="checkbox"/>
Condition ratchet and ratchet strip.....	<input type="checkbox"/>	<input type="checkbox"/>	<input type="checkbox"/>
Condition automotive-lift.....	<input type="checkbox"/>	<input type="checkbox"/>	<input type="checkbox"/>
Condition bolts and bearings	<input type="checkbox"/>	<input type="checkbox"/>	<input type="checkbox"/>
Construction (deformation, cracking)	<input type="checkbox"/>	<input type="checkbox"/>	<input type="checkbox"/>
Function movable rail.....	<input type="checkbox"/>	<input type="checkbox"/>	<input type="checkbox"/>
Condition welding.....	<input type="checkbox"/>	<input type="checkbox"/>	<input type="checkbox"/>
Torque moment of screws and dowels.....	<input type="checkbox"/>	<input type="checkbox"/>	<input type="checkbox"/>
Condition hydraulic unit.....	<input type="checkbox"/>	<input type="checkbox"/>	<input type="checkbox"/>
Condition colour.....	<input type="checkbox"/>	<input type="checkbox"/>	<input type="checkbox"/>
Condition ropes and fastening.....	<input type="checkbox"/>	<input type="checkbox"/>	<input type="checkbox"/>
Condition piston rod.....	<input type="checkbox"/>	<input type="checkbox"/>	<input type="checkbox"/>
Closeness of the hydraulic system.....	<input type="checkbox"/>	<input type="checkbox"/>	<input type="checkbox"/>
Level of hydraulic oil.....	<input type="checkbox"/>	<input type="checkbox"/>	<input type="checkbox"/>
Condition hydraulic hoses.....	<input type="checkbox"/>	<input type="checkbox"/>	<input type="checkbox"/>
Condition electrical cable.....	<input type="checkbox"/>	<input type="checkbox"/>	<input type="checkbox"/>
Condition concrete	<input type="checkbox"/>	<input type="checkbox"/>	<input type="checkbox"/>
Function test with vehicle.....	<input type="checkbox"/>	<input type="checkbox"/>	<input type="checkbox"/>
Function lighting (optional).....	<input type="checkbox"/>	<input type="checkbox"/>	<input type="checkbox"/>

(mark here applicable, in case of verification mark in addition to the first mark!)

Security check carried out:.....

Carried out the company:.....

Name, address of the competent:.....

Result of the Check:

- Initiation not permitted, verification necessary
- Initiation possible, repair failures until.....
- No failings, Initiation possible

.....
signature of the expert

.....
signature of the operator

If failures must be repaired:

Failures repaired at:signature of the operator

(Use another form for verification!)

Regular security check and Maintenance

Serial-no.: _____



Filling out and leave in this manual

kind of check	all right	defect missing	verification	remark
Type plate.....	<input type="checkbox"/>	<input type="checkbox"/>	<input type="checkbox"/>
Short operating instruction.....	<input type="checkbox"/>	<input type="checkbox"/>	<input type="checkbox"/>
Warning designation.....	<input type="checkbox"/>	<input type="checkbox"/>	<input type="checkbox"/>
Sticker max. capacity.....	<input type="checkbox"/>	<input type="checkbox"/>	<input type="checkbox"/>
Designation lifting/lowering.....	<input type="checkbox"/>	<input type="checkbox"/>	<input type="checkbox"/>
Detailed operating instruction.....	<input type="checkbox"/>	<input type="checkbox"/>	<input type="checkbox"/>
Lockable main switch.....	<input type="checkbox"/>	<input type="checkbox"/>	<input type="checkbox"/>
Condition, Function Button „Lifting“.....	<input type="checkbox"/>	<input type="checkbox"/>	<input type="checkbox"/>
Condition, Function Lever „Lowering“.....	<input type="checkbox"/>	<input type="checkbox"/>	<input type="checkbox"/>
Function Button „unlocking ratchet“.....	<input type="checkbox"/>	<input type="checkbox"/>	<input type="checkbox"/>
Function „Lowering into the ratchet“.....	<input type="checkbox"/>	<input type="checkbox"/>	<input type="checkbox"/>
Condition „roll over safety device“.....	<input type="checkbox"/>	<input type="checkbox"/>	<input type="checkbox"/>
Condition Cover.....	<input type="checkbox"/>	<input type="checkbox"/>	<input type="checkbox"/>
Condition ratchet and ratchet strip.....	<input type="checkbox"/>	<input type="checkbox"/>	<input type="checkbox"/>
Condition automotive-lift.....	<input type="checkbox"/>	<input type="checkbox"/>	<input type="checkbox"/>
Condition bolts and bearings.....	<input type="checkbox"/>	<input type="checkbox"/>	<input type="checkbox"/>
Construction (deformation, cracking).....	<input type="checkbox"/>	<input type="checkbox"/>	<input type="checkbox"/>
Function movable rail.....	<input type="checkbox"/>	<input type="checkbox"/>	<input type="checkbox"/>
Condition welding.....	<input type="checkbox"/>	<input type="checkbox"/>	<input type="checkbox"/>
Torque moment of screws and dowels.....	<input type="checkbox"/>	<input type="checkbox"/>	<input type="checkbox"/>
Condition hydraulic unit.....	<input type="checkbox"/>	<input type="checkbox"/>	<input type="checkbox"/>
Condition colour.....	<input type="checkbox"/>	<input type="checkbox"/>	<input type="checkbox"/>
Condition ropes and fastening.....	<input type="checkbox"/>	<input type="checkbox"/>	<input type="checkbox"/>
Condition piston rod.....	<input type="checkbox"/>	<input type="checkbox"/>	<input type="checkbox"/>
Closeness of the hydraulic system.....	<input type="checkbox"/>	<input type="checkbox"/>	<input type="checkbox"/>
Level of hydraulic oil.....	<input type="checkbox"/>	<input type="checkbox"/>	<input type="checkbox"/>
Condition hydraulic hoses.....	<input type="checkbox"/>	<input type="checkbox"/>	<input type="checkbox"/>
Condition electrical cable.....	<input type="checkbox"/>	<input type="checkbox"/>	<input type="checkbox"/>
Condition concrete.....	<input type="checkbox"/>	<input type="checkbox"/>	<input type="checkbox"/>
Function test with vehicle.....	<input type="checkbox"/>	<input type="checkbox"/>	<input type="checkbox"/>
Function lighting (optional).....	<input type="checkbox"/>	<input type="checkbox"/>	<input type="checkbox"/>

(mark here applicable, in case of verification mark in addition to the first mark!)

Security check carried out:.....

Carried out the company:.....

Name, address of the competent:.....

Result of the Check:

- Initiation not permitted, verification necessary
- Initiation possible, repair failures until.....
- No failings, Initiation possible

.....
signature of the expert

.....
signature of the operator

If failures must be repaired:

Failures repaired at:signature of the operator

(Use another form for verification!)

Regular security check and maintenance

Serial-no.: _____



Filling out and leave in this manual

kind of check	all right	defect missing	verification	remark
Type plate.....	<input type="checkbox"/>	<input type="checkbox"/>	<input type="checkbox"/>
Short operating instruction.....	<input type="checkbox"/>	<input type="checkbox"/>	<input type="checkbox"/>
Warning designation.....	<input type="checkbox"/>	<input type="checkbox"/>	<input type="checkbox"/>
Sticker max. capacity.....	<input type="checkbox"/>	<input type="checkbox"/>	<input type="checkbox"/>
Designation lifting/lowering.....	<input type="checkbox"/>	<input type="checkbox"/>	<input type="checkbox"/>
Detailed operating instruction.....	<input type="checkbox"/>	<input type="checkbox"/>	<input type="checkbox"/>
Lockable main switch.....	<input type="checkbox"/>	<input type="checkbox"/>	<input type="checkbox"/>
Condition, Function Button „Lifting“.....	<input type="checkbox"/>	<input type="checkbox"/>	<input type="checkbox"/>
Condition, Function Lever „Lowering „.....	<input type="checkbox"/>	<input type="checkbox"/>	<input type="checkbox"/>
Function Button „unlocking ratchet“.....	<input type="checkbox"/>	<input type="checkbox"/>	<input type="checkbox"/>
Function „Lowering into the ratchet“.....	<input type="checkbox"/>	<input type="checkbox"/>	<input type="checkbox"/>
Condition „roll over safety device“.....	<input type="checkbox"/>	<input type="checkbox"/>	<input type="checkbox"/>
Condition Cover.....	<input type="checkbox"/>	<input type="checkbox"/>	<input type="checkbox"/>
Condition ratchet and ratchet strip.....	<input type="checkbox"/>	<input type="checkbox"/>	<input type="checkbox"/>
Condition automotive-lift.....	<input type="checkbox"/>	<input type="checkbox"/>	<input type="checkbox"/>
Condition bolts and bearings	<input type="checkbox"/>	<input type="checkbox"/>	<input type="checkbox"/>
Construction (deformation, cracking)	<input type="checkbox"/>	<input type="checkbox"/>	<input type="checkbox"/>
Function movable rail.....	<input type="checkbox"/>	<input type="checkbox"/>	<input type="checkbox"/>
Condition welding.....	<input type="checkbox"/>	<input type="checkbox"/>	<input type="checkbox"/>
Torque moment of screws and dowels.....	<input type="checkbox"/>	<input type="checkbox"/>	<input type="checkbox"/>
Condition hydraulic unit.....	<input type="checkbox"/>	<input type="checkbox"/>	<input type="checkbox"/>
Condition colour.....	<input type="checkbox"/>	<input type="checkbox"/>	<input type="checkbox"/>
Condition ropes and fastening.....	<input type="checkbox"/>	<input type="checkbox"/>	<input type="checkbox"/>
Condition piston rod.....	<input type="checkbox"/>	<input type="checkbox"/>	<input type="checkbox"/>
Closeness of the hydraulic system.....	<input type="checkbox"/>	<input type="checkbox"/>	<input type="checkbox"/>
Level of hydraulic oil.....	<input type="checkbox"/>	<input type="checkbox"/>	<input type="checkbox"/>
Condition hydraulic hoses.....	<input type="checkbox"/>	<input type="checkbox"/>	<input type="checkbox"/>
Condition electrical cable.....	<input type="checkbox"/>	<input type="checkbox"/>	<input type="checkbox"/>
Condition concrete	<input type="checkbox"/>	<input type="checkbox"/>	<input type="checkbox"/>
Function test with vehicle.....	<input type="checkbox"/>	<input type="checkbox"/>	<input type="checkbox"/>
Function lighting (optional).....	<input type="checkbox"/>	<input type="checkbox"/>	<input type="checkbox"/>

(mark here applicable, in case of verification mark in addition to the first mark!)

Security check carried out:.....

Carried out the company:.....

Name, address of the competent:.....

Result of the Check:

- Initiation not permitted, verification necessary
- Initiation possible, repair failures until.....
- No failings, Initiation possible

.....
signature of the expert

.....
signature of the operator

If failures must be repaired:

Failures repaired at:signature of the operator
(Use another form for verification!)

Regular security check and maintenance

Serial-no.: _____



Filling out and leave in this manual

kind of check	all right	defect missing	verification	remark
Type plate.....	<input type="checkbox"/>	<input type="checkbox"/>	<input type="checkbox"/>
Short operating instruction.....	<input type="checkbox"/>	<input type="checkbox"/>	<input type="checkbox"/>
Warning designation.....	<input type="checkbox"/>	<input type="checkbox"/>	<input type="checkbox"/>
Sticker max. capacity.....	<input type="checkbox"/>	<input type="checkbox"/>	<input type="checkbox"/>
Designation lifting/lowering.....	<input type="checkbox"/>	<input type="checkbox"/>	<input type="checkbox"/>
Detailed operating instruction.....	<input type="checkbox"/>	<input type="checkbox"/>	<input type="checkbox"/>
Lockable main switch.....	<input type="checkbox"/>	<input type="checkbox"/>	<input type="checkbox"/>
Condition, Function Button „Lifting“.....	<input type="checkbox"/>	<input type="checkbox"/>	<input type="checkbox"/>
Condition, Function Lever „Lowering „.....	<input type="checkbox"/>	<input type="checkbox"/>	<input type="checkbox"/>
Function Button „unlocking ratchet“.....	<input type="checkbox"/>	<input type="checkbox"/>	<input type="checkbox"/>
Function „Lowering into the ratchet“.....	<input type="checkbox"/>	<input type="checkbox"/>	<input type="checkbox"/>
Condition „roll over safety device“.....	<input type="checkbox"/>	<input type="checkbox"/>	<input type="checkbox"/>
Condition Cover.....	<input type="checkbox"/>	<input type="checkbox"/>	<input type="checkbox"/>
Condition ratchet and ratchet strip.....	<input type="checkbox"/>	<input type="checkbox"/>	<input type="checkbox"/>
Condition automotive-lift.....	<input type="checkbox"/>	<input type="checkbox"/>	<input type="checkbox"/>
Condition bolts and bearings	<input type="checkbox"/>	<input type="checkbox"/>	<input type="checkbox"/>
Construction (deformation, cracking)	<input type="checkbox"/>	<input type="checkbox"/>	<input type="checkbox"/>
Function movable rail.....	<input type="checkbox"/>	<input type="checkbox"/>	<input type="checkbox"/>
Condition welding.....	<input type="checkbox"/>	<input type="checkbox"/>	<input type="checkbox"/>
Torque moment of screws and dowels.....	<input type="checkbox"/>	<input type="checkbox"/>	<input type="checkbox"/>
Condition hydraulic unit.....	<input type="checkbox"/>	<input type="checkbox"/>	<input type="checkbox"/>
Condition colour.....	<input type="checkbox"/>	<input type="checkbox"/>	<input type="checkbox"/>
Condition ropes and fastening.....	<input type="checkbox"/>	<input type="checkbox"/>	<input type="checkbox"/>
Condition piston rod.....	<input type="checkbox"/>	<input type="checkbox"/>	<input type="checkbox"/>
Closeness of the hydraulic system.....	<input type="checkbox"/>	<input type="checkbox"/>	<input type="checkbox"/>
Level of hydraulic oil.....	<input type="checkbox"/>	<input type="checkbox"/>	<input type="checkbox"/>
Condition hydraulic hoses.....	<input type="checkbox"/>	<input type="checkbox"/>	<input type="checkbox"/>
Condition electrical cable.....	<input type="checkbox"/>	<input type="checkbox"/>	<input type="checkbox"/>
Condition concrete	<input type="checkbox"/>	<input type="checkbox"/>	<input type="checkbox"/>
Function test with vehicle.....	<input type="checkbox"/>	<input type="checkbox"/>	<input type="checkbox"/>
Function lighting (optional).....	<input type="checkbox"/>	<input type="checkbox"/>	<input type="checkbox"/>

(mark here applicable, in case of verification mark in addition to the first mark!)

Security check carried out:.....

Carried out the company:.....

Name, address of the competent:.....

Result of the Check:

- Initiation not permitted, verification necessary
- Initiation possible, repair failures until.....
- No failings, Initiation possible

.....
signature of the expert

.....
signature of the operator

If failures must be repaired:

Failures repaired at:signature of the operator
(Use another form for verification!)

Regular security check and maintenance

Serial-no.: _____



Filling out and leave in this manual

kind of check	all right	defect missing	verification	remark
Type plate.....	<input type="checkbox"/>	<input type="checkbox"/>	<input type="checkbox"/>
Short operating instruction.....	<input type="checkbox"/>	<input type="checkbox"/>	<input type="checkbox"/>
Warning designation.....	<input type="checkbox"/>	<input type="checkbox"/>	<input type="checkbox"/>
Sticker max. capacity.....	<input type="checkbox"/>	<input type="checkbox"/>	<input type="checkbox"/>
Designation lifting/lowering.....	<input type="checkbox"/>	<input type="checkbox"/>	<input type="checkbox"/>
Detailed operating instruction.....	<input type="checkbox"/>	<input type="checkbox"/>	<input type="checkbox"/>
Lockable main switch.....	<input type="checkbox"/>	<input type="checkbox"/>	<input type="checkbox"/>
Condition, Function Button „Lifting“.....	<input type="checkbox"/>	<input type="checkbox"/>	<input type="checkbox"/>
Condition, Function Lever „Lowering „.....	<input type="checkbox"/>	<input type="checkbox"/>	<input type="checkbox"/>
Function Button „unlocking ratchet“.....	<input type="checkbox"/>	<input type="checkbox"/>	<input type="checkbox"/>
Function „Lowering into the ratchet“.....	<input type="checkbox"/>	<input type="checkbox"/>	<input type="checkbox"/>
Condition „roll over safety device“.....	<input type="checkbox"/>	<input type="checkbox"/>	<input type="checkbox"/>
Condition Cover.....	<input type="checkbox"/>	<input type="checkbox"/>	<input type="checkbox"/>
Condition ratchet and ratchet strip.....	<input type="checkbox"/>	<input type="checkbox"/>	<input type="checkbox"/>
Condition automotive-lift.....	<input type="checkbox"/>	<input type="checkbox"/>	<input type="checkbox"/>
Condition bolts and bearings	<input type="checkbox"/>	<input type="checkbox"/>	<input type="checkbox"/>
Construction (deformation, cracking)	<input type="checkbox"/>	<input type="checkbox"/>	<input type="checkbox"/>
Function movable rail.....	<input type="checkbox"/>	<input type="checkbox"/>	<input type="checkbox"/>
Condition welding.....	<input type="checkbox"/>	<input type="checkbox"/>	<input type="checkbox"/>
Torque moment of screws and dowels.....	<input type="checkbox"/>	<input type="checkbox"/>	<input type="checkbox"/>
Condition hydraulic unit.....	<input type="checkbox"/>	<input type="checkbox"/>	<input type="checkbox"/>
Condition colour.....	<input type="checkbox"/>	<input type="checkbox"/>	<input type="checkbox"/>
Condition ropes and fastening.....	<input type="checkbox"/>	<input type="checkbox"/>	<input type="checkbox"/>
Condition piston rod.....	<input type="checkbox"/>	<input type="checkbox"/>	<input type="checkbox"/>
Closeness of the hydraulic system.....	<input type="checkbox"/>	<input type="checkbox"/>	<input type="checkbox"/>
Level of hydraulic oil.....	<input type="checkbox"/>	<input type="checkbox"/>	<input type="checkbox"/>
Condition hydraulic hoses.....	<input type="checkbox"/>	<input type="checkbox"/>	<input type="checkbox"/>
Condition electrical cable.....	<input type="checkbox"/>	<input type="checkbox"/>	<input type="checkbox"/>
Condition concrete	<input type="checkbox"/>	<input type="checkbox"/>	<input type="checkbox"/>
Function test with vehicle.....	<input type="checkbox"/>	<input type="checkbox"/>	<input type="checkbox"/>
Function lighting (optional).....	<input type="checkbox"/>	<input type="checkbox"/>	<input type="checkbox"/>

(mark here applicable, in case of verification mark in addition to the first mark!)

Security check carried out:.....

Carried out the company:.....

Name, address of the competent:.....

Result of the Check:

- Initiation not permitted, verification necessary
- Initiation possible, repair failures until.....
- No failings, Initiation possible

.....
signature of the expert

.....
signature of the operator

If failures must be repaired:

Failures repaired at:signature of the operator
(Use another form for verification!)

Regular security check and maintenance

Serial-no.: _____



Filling out and leave in this manual

kind of check	all right	defect missing	verification	remark
Type plate.....	<input type="checkbox"/>	<input type="checkbox"/>	<input type="checkbox"/>
Short operating instruction.....	<input type="checkbox"/>	<input type="checkbox"/>	<input type="checkbox"/>
Warning designation.....	<input type="checkbox"/>	<input type="checkbox"/>	<input type="checkbox"/>
Sticker max. capacity.....	<input type="checkbox"/>	<input type="checkbox"/>	<input type="checkbox"/>
Designation lifting/lowering.....	<input type="checkbox"/>	<input type="checkbox"/>	<input type="checkbox"/>
Detailed operating instruction.....	<input type="checkbox"/>	<input type="checkbox"/>	<input type="checkbox"/>
Lockable main switch.....	<input type="checkbox"/>	<input type="checkbox"/>	<input type="checkbox"/>
Condition, Function Button „Lifting“.....	<input type="checkbox"/>	<input type="checkbox"/>	<input type="checkbox"/>
Condition, Function Lever „Lowering „.....	<input type="checkbox"/>	<input type="checkbox"/>	<input type="checkbox"/>
Function Button „unlocking ratchet“.....	<input type="checkbox"/>	<input type="checkbox"/>	<input type="checkbox"/>
Function „Lowering into the ratchet“.....	<input type="checkbox"/>	<input type="checkbox"/>	<input type="checkbox"/>
Condition „roll over safety device“.....	<input type="checkbox"/>	<input type="checkbox"/>	<input type="checkbox"/>
Condition Cover.....	<input type="checkbox"/>	<input type="checkbox"/>	<input type="checkbox"/>
Condition ratchet and ratchet strip.....	<input type="checkbox"/>	<input type="checkbox"/>	<input type="checkbox"/>
Condition automotive-lift.....	<input type="checkbox"/>	<input type="checkbox"/>	<input type="checkbox"/>
Condition bolts and bearings	<input type="checkbox"/>	<input type="checkbox"/>	<input type="checkbox"/>
Construction (deformation, cracking)	<input type="checkbox"/>	<input type="checkbox"/>	<input type="checkbox"/>
Function movable rail.....	<input type="checkbox"/>	<input type="checkbox"/>	<input type="checkbox"/>
Condition welding.....	<input type="checkbox"/>	<input type="checkbox"/>	<input type="checkbox"/>
Torque moment of screws and dowels.....	<input type="checkbox"/>	<input type="checkbox"/>	<input type="checkbox"/>
Condition hydraulic unit.....	<input type="checkbox"/>	<input type="checkbox"/>	<input type="checkbox"/>
Condition colour.....	<input type="checkbox"/>	<input type="checkbox"/>	<input type="checkbox"/>
Condition ropes and fastening.....	<input type="checkbox"/>	<input type="checkbox"/>	<input type="checkbox"/>
Condition piston rod.....	<input type="checkbox"/>	<input type="checkbox"/>	<input type="checkbox"/>
Closeness of the hydraulic system.....	<input type="checkbox"/>	<input type="checkbox"/>	<input type="checkbox"/>
Level of hydraulic oil.....	<input type="checkbox"/>	<input type="checkbox"/>	<input type="checkbox"/>
Condition hydraulic hoses.....	<input type="checkbox"/>	<input type="checkbox"/>	<input type="checkbox"/>
Condition electrical cable.....	<input type="checkbox"/>	<input type="checkbox"/>	<input type="checkbox"/>
Condition concrete	<input type="checkbox"/>	<input type="checkbox"/>	<input type="checkbox"/>
Function test with vehicle.....	<input type="checkbox"/>	<input type="checkbox"/>	<input type="checkbox"/>
Function lighting (optional).....	<input type="checkbox"/>	<input type="checkbox"/>	<input type="checkbox"/>

(mark here applicable, in case of verification mark in addition to the first mark!)

Security check carried out:.....

Carried out the company:.....

Name, address of the competent:.....

Result of the Check:

- Initiation not permitted, verification necessary
- Initiation possible, repair failures until.....
- No failings, Initiation possible

.....
signature of the expert

.....
signature of the operator

If failures must be repaired:

Failures repaired at:signature of the operator
(Use another form for verification!)

Regular security check and maintenance

Serial-no.: _____



Filling out and leave in this manual

kind of check	all right	defect missing	ver-ification	remark
Type plate.....	<input type="checkbox"/>	<input type="checkbox"/>	<input type="checkbox"/>
Short operating instruction.....	<input type="checkbox"/>	<input type="checkbox"/>	<input type="checkbox"/>
Warning designation.....	<input type="checkbox"/>	<input type="checkbox"/>	<input type="checkbox"/>
Sticker max. capacity.....	<input type="checkbox"/>	<input type="checkbox"/>	<input type="checkbox"/>
Designation lifting/lowering.....	<input type="checkbox"/>	<input type="checkbox"/>	<input type="checkbox"/>
Detailed operating instruction.....	<input type="checkbox"/>	<input type="checkbox"/>	<input type="checkbox"/>
Lockable main switch.....	<input type="checkbox"/>	<input type="checkbox"/>	<input type="checkbox"/>
Condition, Function Button „Lifting“.....	<input type="checkbox"/>	<input type="checkbox"/>	<input type="checkbox"/>
Condition, Function Lever „Lowering „.....	<input type="checkbox"/>	<input type="checkbox"/>	<input type="checkbox"/>
Function Button „unlocking ratchet“.....	<input type="checkbox"/>	<input type="checkbox"/>	<input type="checkbox"/>
Function „Lowering into the ratchet“.....	<input type="checkbox"/>	<input type="checkbox"/>	<input type="checkbox"/>
Condition „roll over safety device“.....	<input type="checkbox"/>	<input type="checkbox"/>	<input type="checkbox"/>
Condition Cover.....	<input type="checkbox"/>	<input type="checkbox"/>	<input type="checkbox"/>
Condition ratchet and ratchet strip.....	<input type="checkbox"/>	<input type="checkbox"/>	<input type="checkbox"/>
Condition automotive-lift.....	<input type="checkbox"/>	<input type="checkbox"/>	<input type="checkbox"/>
Condition bolts and bearings	<input type="checkbox"/>	<input type="checkbox"/>	<input type="checkbox"/>
Construction (deformation, cracking)	<input type="checkbox"/>	<input type="checkbox"/>	<input type="checkbox"/>
Function movable rail.....	<input type="checkbox"/>	<input type="checkbox"/>	<input type="checkbox"/>
Condition welding.....	<input type="checkbox"/>	<input type="checkbox"/>	<input type="checkbox"/>
Torque moment of screws and dowels.....	<input type="checkbox"/>	<input type="checkbox"/>	<input type="checkbox"/>
Condition hydraulic unit.....	<input type="checkbox"/>	<input type="checkbox"/>	<input type="checkbox"/>
Condition colour.....	<input type="checkbox"/>	<input type="checkbox"/>	<input type="checkbox"/>
Condition ropes and fastening.....	<input type="checkbox"/>	<input type="checkbox"/>	<input type="checkbox"/>
Condition piston rod.....	<input type="checkbox"/>	<input type="checkbox"/>	<input type="checkbox"/>
Closeness of the hydraulic system.....	<input type="checkbox"/>	<input type="checkbox"/>	<input type="checkbox"/>
Level of hydraulic oil.....	<input type="checkbox"/>	<input type="checkbox"/>	<input type="checkbox"/>
Condition hydraulic hoses.....	<input type="checkbox"/>	<input type="checkbox"/>	<input type="checkbox"/>
Condition electrical cable.....	<input type="checkbox"/>	<input type="checkbox"/>	<input type="checkbox"/>
Condition concrete	<input type="checkbox"/>	<input type="checkbox"/>	<input type="checkbox"/>
Function test with vehicle.....	<input type="checkbox"/>	<input type="checkbox"/>	<input type="checkbox"/>
Function lighting (optional).....	<input type="checkbox"/>	<input type="checkbox"/>	<input type="checkbox"/>

(mark here applicable, in case of verification mark in addition to the first mark!)

Security check carried out:.....

Carried out the company:.....

Name, address of the competent:.....

Result of the Check:

- Initiation not permitted, verification necessary
- Initiation possible, repair failures until.....
- No failings, Initiation possible

.....
signature of the expert

.....
signature of the operator

If failures must be repaired:

Failures repaired at:signature of the operator
(Use another form for verification!)

Regular security check and maintenance

Serial-no.: _____



Filling out and leave in this manual

kind of check	all right	defect missing	verification	remark
Type plate.....	<input type="checkbox"/>	<input type="checkbox"/>	<input type="checkbox"/>
Short operating instruction.....	<input type="checkbox"/>	<input type="checkbox"/>	<input type="checkbox"/>
Warning designation.....	<input type="checkbox"/>	<input type="checkbox"/>	<input type="checkbox"/>
Sticker max. capacity.....	<input type="checkbox"/>	<input type="checkbox"/>	<input type="checkbox"/>
Designation lifting/lowering.....	<input type="checkbox"/>	<input type="checkbox"/>	<input type="checkbox"/>
Detailed operating instruction.....	<input type="checkbox"/>	<input type="checkbox"/>	<input type="checkbox"/>
Lockable main switch.....	<input type="checkbox"/>	<input type="checkbox"/>	<input type="checkbox"/>
Condition, Function Button „Lifting“.....	<input type="checkbox"/>	<input type="checkbox"/>	<input type="checkbox"/>
Condition, Function Lever „Lowering „.....	<input type="checkbox"/>	<input type="checkbox"/>	<input type="checkbox"/>
Function Button „unlocking ratchet“.....	<input type="checkbox"/>	<input type="checkbox"/>	<input type="checkbox"/>
Function „Lowering into the ratchet“.....	<input type="checkbox"/>	<input type="checkbox"/>	<input type="checkbox"/>
Condition „roll over safety device“.....	<input type="checkbox"/>	<input type="checkbox"/>	<input type="checkbox"/>
Condition Cover.....	<input type="checkbox"/>	<input type="checkbox"/>	<input type="checkbox"/>
Condition ratchet and ratchet strip.....	<input type="checkbox"/>	<input type="checkbox"/>	<input type="checkbox"/>
Condition automotive-lift.....	<input type="checkbox"/>	<input type="checkbox"/>	<input type="checkbox"/>
Condition bolts and bearings	<input type="checkbox"/>	<input type="checkbox"/>	<input type="checkbox"/>
Construction (deformation, cracking)	<input type="checkbox"/>	<input type="checkbox"/>	<input type="checkbox"/>
Function movable rail.....	<input type="checkbox"/>	<input type="checkbox"/>	<input type="checkbox"/>
Condition welding.....	<input type="checkbox"/>	<input type="checkbox"/>	<input type="checkbox"/>
Torque moment of screws and dowels.....	<input type="checkbox"/>	<input type="checkbox"/>	<input type="checkbox"/>
Condition hydraulic unit.....	<input type="checkbox"/>	<input type="checkbox"/>	<input type="checkbox"/>
Condition colour.....	<input type="checkbox"/>	<input type="checkbox"/>	<input type="checkbox"/>
Condition ropes and fastening.....	<input type="checkbox"/>	<input type="checkbox"/>	<input type="checkbox"/>
Condition piston rod.....	<input type="checkbox"/>	<input type="checkbox"/>	<input type="checkbox"/>
Closeness of the hydraulic system.....	<input type="checkbox"/>	<input type="checkbox"/>	<input type="checkbox"/>
Level of hydraulic oil.....	<input type="checkbox"/>	<input type="checkbox"/>	<input type="checkbox"/>
Condition hydraulic hoses.....	<input type="checkbox"/>	<input type="checkbox"/>	<input type="checkbox"/>
Condition electrical cable.....	<input type="checkbox"/>	<input type="checkbox"/>	<input type="checkbox"/>
Condition concrete	<input type="checkbox"/>	<input type="checkbox"/>	<input type="checkbox"/>
Function test with vehicle.....	<input type="checkbox"/>	<input type="checkbox"/>	<input type="checkbox"/>
Function lighting (optional).....	<input type="checkbox"/>	<input type="checkbox"/>	<input type="checkbox"/>

(mark here applicable, in case of verification mark in addition to the first mark!)

Security check carried out:.....

Carried out the company:.....

Name, address of the competent:.....

Result of the Check:

- Initiation not permitted, verification necessary
- Initiation possible, repair failures until.....
- No failings, Initiation possible

.....
signature of the expert

.....
signature of the operator

If failures must be repaired:

Failures repaired at:signature of the operator
(Use another form for verification!)

Extraordinary security check

Serial-no.: _____



Filling out and leave in this manual

kind of check	all right	defect missing	verification	remark
Type plate.....	<input type="checkbox"/>	<input type="checkbox"/>	<input type="checkbox"/>
Short operating instruction.....	<input type="checkbox"/>	<input type="checkbox"/>	<input type="checkbox"/>
Warning designation.....	<input type="checkbox"/>	<input type="checkbox"/>	<input type="checkbox"/>
Sticker max. capacity.....	<input type="checkbox"/>	<input type="checkbox"/>	<input type="checkbox"/>
Designation lifting/lowering.....	<input type="checkbox"/>	<input type="checkbox"/>	<input type="checkbox"/>
Detailed operating instruction.....	<input type="checkbox"/>	<input type="checkbox"/>	<input type="checkbox"/>
Lockable main switch.....	<input type="checkbox"/>	<input type="checkbox"/>	<input type="checkbox"/>
Condition, Function Button „Lifting“.....	<input type="checkbox"/>	<input type="checkbox"/>	<input type="checkbox"/>
Condition, Function Lever „Lowering“.....	<input type="checkbox"/>	<input type="checkbox"/>	<input type="checkbox"/>
Function Button „unlocking ratchet“.....	<input type="checkbox"/>	<input type="checkbox"/>	<input type="checkbox"/>
Function „Lowering into the ratchet“.....	<input type="checkbox"/>	<input type="checkbox"/>	<input type="checkbox"/>
Condition „roll over safety device“.....	<input type="checkbox"/>	<input type="checkbox"/>	<input type="checkbox"/>
Condition Cover.....	<input type="checkbox"/>	<input type="checkbox"/>	<input type="checkbox"/>
Condition ratchet and ratchet strip.....	<input type="checkbox"/>	<input type="checkbox"/>	<input type="checkbox"/>
Condition automotive-lift.....	<input type="checkbox"/>	<input type="checkbox"/>	<input type="checkbox"/>
Condition bolts and bearings.....	<input type="checkbox"/>	<input type="checkbox"/>	<input type="checkbox"/>
Construction (deformation, cracking).....	<input type="checkbox"/>	<input type="checkbox"/>	<input type="checkbox"/>
Function movable rail.....	<input type="checkbox"/>	<input type="checkbox"/>	<input type="checkbox"/>
Condition welding.....	<input type="checkbox"/>	<input type="checkbox"/>	<input type="checkbox"/>
Torque moment of screws and dowels.....	<input type="checkbox"/>	<input type="checkbox"/>	<input type="checkbox"/>
Condition hydraulic unit.....	<input type="checkbox"/>	<input type="checkbox"/>	<input type="checkbox"/>
Condition colour.....	<input type="checkbox"/>	<input type="checkbox"/>	<input type="checkbox"/>
Condition ropes and fastening.....	<input type="checkbox"/>	<input type="checkbox"/>	<input type="checkbox"/>
Condition piston rod.....	<input type="checkbox"/>	<input type="checkbox"/>	<input type="checkbox"/>
Closeness of the hydraulic system.....	<input type="checkbox"/>	<input type="checkbox"/>	<input type="checkbox"/>
Level of hydraulic oil.....	<input type="checkbox"/>	<input type="checkbox"/>	<input type="checkbox"/>
Condition hydraulic hoses.....	<input type="checkbox"/>	<input type="checkbox"/>	<input type="checkbox"/>
Condition electrical cable.....	<input type="checkbox"/>	<input type="checkbox"/>	<input type="checkbox"/>
Condition concrete.....	<input type="checkbox"/>	<input type="checkbox"/>	<input type="checkbox"/>
Function test with vehicle.....	<input type="checkbox"/>	<input type="checkbox"/>	<input type="checkbox"/>
Function lighting (optional).....	<input type="checkbox"/>	<input type="checkbox"/>	<input type="checkbox"/>

(mark here applicable, in case of verification mark in addition to the first mark!)

Security check carried out:.....

Carried out the company:.....

Name, address of the competent:.....

Result of the Check:

- Initiation not permitted, verification necessary
- Initiation possible, repair failures until.....
- No failings, Initiation possible

.....
signature of the expert

.....
signature of the operator

If failures must be repaired:

Failures repaired at:signature of the operator
(Use another form for verification!)